

GiantArm D200 User Manual



Version 1

Contents

1. Introduction	3
1.1 Terms	3
1.2 Safety and Compliance	4
1.3 About GiantArm D200	6
2. Unpacking GiantArm D200	9
2.1 Un-box.....	9
2.2 Accessory Checklist.....	10
2.3 Printer set up.....	11
3. GiantArm D200 Control Panel	16
3.1 Home	16
3.2 Move.....	17
3.3 Setting.....	19
3.4 Print from SD Card.....	30
3.5 Information	31
3.6 Status Bar.....	33
3.7 Other information	34
4. Leveling.....	36
4.1 Coarse tuning.....	36
4.2 Fine tuning.....	37
5. Load filament	40
6. Start to print.....	43
6.1 Print from SD card.....	43
6.2 Print via USB Serial Port.....	44
6.2.1 EasyPrint 3D Installation and Configuration.....	44
6.2.2 Load a File.....	48
6.2.3 Printing Setting	48
6.2.4 Slicing.....	63
6.2.5 Save slicing.....	64
6.3 Print via Wi-Fi	65
7. Featured Functions of GIANTARM D200	80
7.1 Break-resuming	80
7.2 Filament detector	85
8. FAQ	89
8.1 About printing problem	89
8.2 How to upload the firmware?	94
8.3 How to change the extruder.....	96
9. Technical Specifications	99
10 Contact us	100

1. Introduction

1.1 Terms

Please be advised of the following terms (the “Terms”) regarding this User Manual (this “Manual”):

All information in this Manual is subject to change at any time without notice and is provided for convenience purposes only. Geeetech reserves the right to modify or revise this Manual in its sole discretion and at any time. You agree to be bound by any modifications and/or revisions. Contact the Geeetech Support Team for up-to-date information.

Content Copyright. The design of this Manual and all text, graphics, information, content, and other material are protected by copyright and other laws. The contents are copyright 2017 Shenzhen Getech Technology CO, LTD, or our respective affiliates and suppliers.

All rights reserved. Certain trademarks, trade names, service marks, and logos (the “Marks”) used in this Manual are registered and unregistered trademarks, trade names, and service marks of Geeetech and its affiliates. Nothing contained in this Manual grants or should be construed as granting, by implication, estoppel, or otherwise, any license or right to use any Marks without the written permission of Geeetech. Any unauthorized use of any information, materials, or Marks may violate copyright laws, trademark laws, laws of privacy and publicity, and/or other laws and regulations.

DISCLAIMERS. Neither Geeetech nor any of our affiliates warrants the accuracy or completeness of the information, products, or services provided by or through this Manual, which are provided “as is” and without any express or implied warranties of any kind, including warranties of merchantability, fitness for a particular purpose, or non-infringement of intellectual property. To the fullest extent permissible by the applicable law, we hereby disclaim all liability for product defect or failure or for claims that are due to normal wear, product misuse or abuse, product modification, improper product selection, noncompliance with any codes, or misappropriation. To the fullest extent permissible by the applicable law, we hereby disclaim any and all responsibility, risk, liability, and damages arising out of death or personal injury resulting from assembly or operation of our products. Geeetech assumes no responsibility, nor will be liable, for any damages to, or any viruses or malware that may infect your computer, telecommunication

equipment, or other property caused by or arising from your downloading of any information or materials related to Geeetech products. The foregoing exclusions do not apply to the extent prohibited by law; please refer to your local laws for any such prohibitions. We make no warranties to those defined as “consumers” in the Magnuson-Moss Warranty–Federal Trade Commission Improvement Act.

LIMITATIONS OF LIABILITY. In no event will Geeetech or any of our respective officers, directors, employees, shareholders, affiliates, agents, successors, or assigns, nor any party involved in the creation or production of our products, be liable to you or anyone else for any indirect, special, punitive, incidental, or consequential damages (including, without limitation, those resulting from lost profits, lost data, or business interruption) arising out of the use, inability to use, or the results of use of this Manual, whether based on warranty, contract, tort, or any other legal theory and whether or not advised of the possibility of such damages. The foregoing limitations of liability do not apply to the extent prohibited by law; please refer to your local laws for any such prohibitions.

1.2 Safety and Compliance

Radio and Television Interference

This equipment has been tested and found to comply with the limits for a Class B digital device, pursuant to Part 15 of the Federal Communications Commission (FCC) rules. These limits are designed to provide reasonable protection against harmful interference in a residential installation. This equipment generates uses and can radiate radio frequency energy and, if not installed and used in accordance with the instructions, may cause harmful interference to radio communications. However, there is no guarantee that interference will not occur in a particular installation. If this equipment does cause harmful interference to radio or television reception, which can be determined by turning the equipment off and on, the user is encouraged to try to correct the interference by one or more of the following measures:

- Reorient or relocate the receiving antenna.
- Increase the separation between the equipment and the receiver.
- Connect the equipment to an outlet on a circuit different from that to which the receiver is connected.
- Consult the dealer or an experienced radio/TV technician for help.

The following booklet compiled by FCC may help you: “How to Identify and Resolve Radio-TV

Interference Problems”









Changes and modifications not expressly approved by the manufacturer or registrant of this equipment will void your right to use the equipment in accordance with FCC regulations.

Radio Specifications

Frequency	WLAN RF Frequency Range	Protocol	Wireless Types	Wireless Specification
2.4 GHz	2.412 - 2.472 GHz	802.11 b/g/n	Taoglas, P/N FX831.07.0100C	Within 2.4 GHz Band 2.5 dBi



Safety alert symbols precede each safety message in this manual. These symbols indicate potential safety hazards that could harm you or others or cause product or property damage.

-  **Warning:** The GiantArm D200 generates high temperatures. Always allow the GiantArm D200 to cool down before you reach inside.
-  **Warning:** The GiantArm D200 includes moving parts that can cause injury. Never reach inside the GiantArm D200 while it is in operation.
-  **Warning:** There is a risk of shock. This product is not user serviceable.
-  **Warning:** Do not leave the GiantArm D200 unattended during operation.
-  **Caution:** Do not print using materials that have not been approved by GEEETEC for use with the GiantArm D200.
-  **Caution:** The socket outlet must be located near the equipment and must be easily accessible.
-  **Caution:** In case of emergency disconnect the GiantArm D200 from the wall socket.
-  **Caution:** The GiantArm D200 melts plastic during printing. Plastic odors are emitted during this operation. Make sure to set up the GiantArm D200 in a well-ventilated area.

1.3 About GiantArm D200

GiantArm D200 is a user-oriented 3D printer newly launched by GiantArm, a high-end brand affiliated with Shenzhen Getech Technology CO, LTD. GiantArm D200 is developed on the basis of FDM 3D printing technology and prototype principle, delivering exquisite and stable 3D objects.

Wi-Fi enabled, GiantArm D200 makes it a reality to direct remote control over the whole printing process by means of EasyPrint App, allowing you to enjoy the convenience and fashion of cloud 3D printing.

Moreover, GiantArm D200 is fully-featured: break-resuming capability, filament detector system, full-color touch screen, modular extruder, serial nozzles, extended build volume, high resolution and fast printing speed and etc. It is designed to get you out of frustrating printing dilemmas and provide you with satisfactory printing experience.

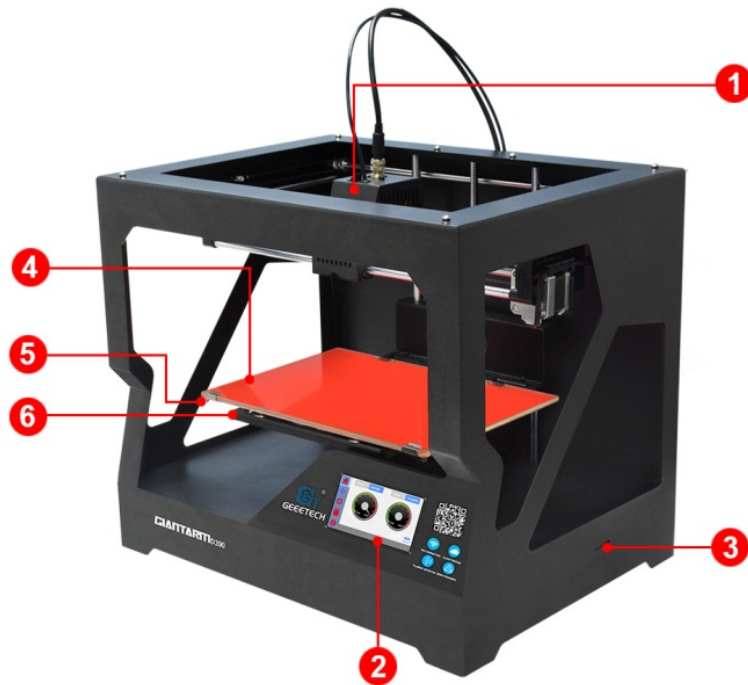

- | | |
|-----------------|-------------------------|
| 1. Extruder | 2. Control panel |
| 3. SD card slot | 4. Heat-resistant glass |
| 5. Heatbed | 6. Build platform |

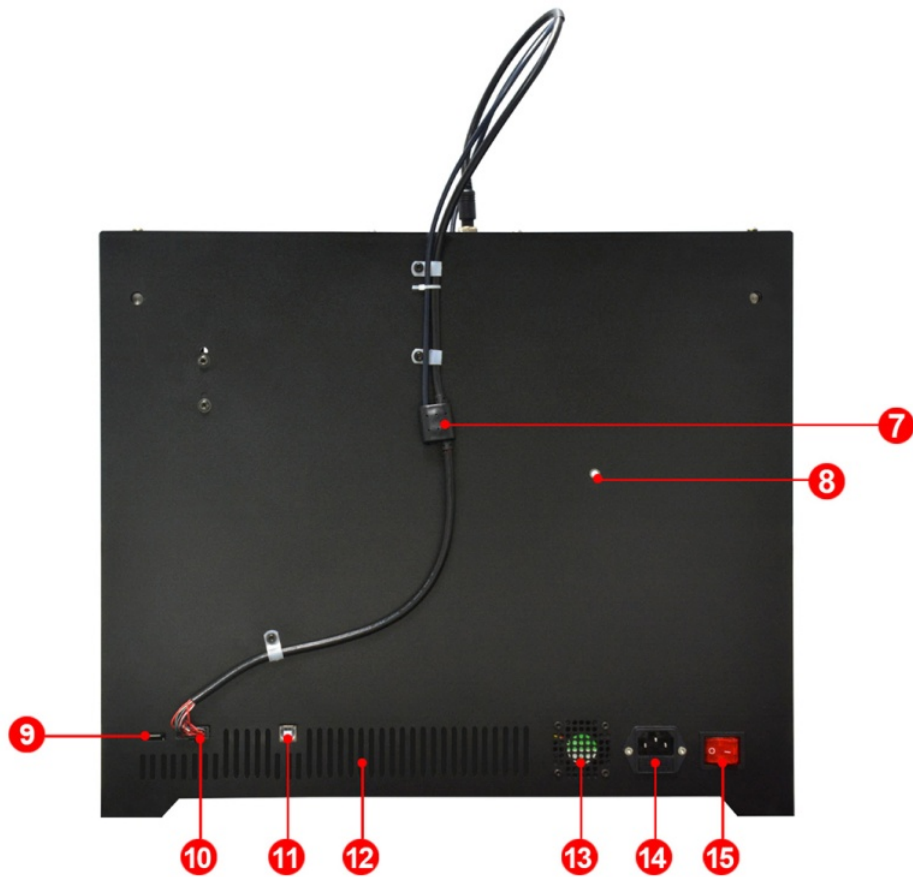

- | | | |
|----------------------|-----------------|------------------|
| 7. Filament detector | 8. Spool holder | 9. Wi-Fi antenna |
| 10. Extruder bar | 11. USB port | 12. Air vents |
| 13. Radiator fan | 14. Power port | 15. Power switch |

2. Unpacking GiantArm D200

2.1 Un-box

Step 1. Open the package box



Step 2. Take out GIANTARM D200 from the box; put it on the flat surface.

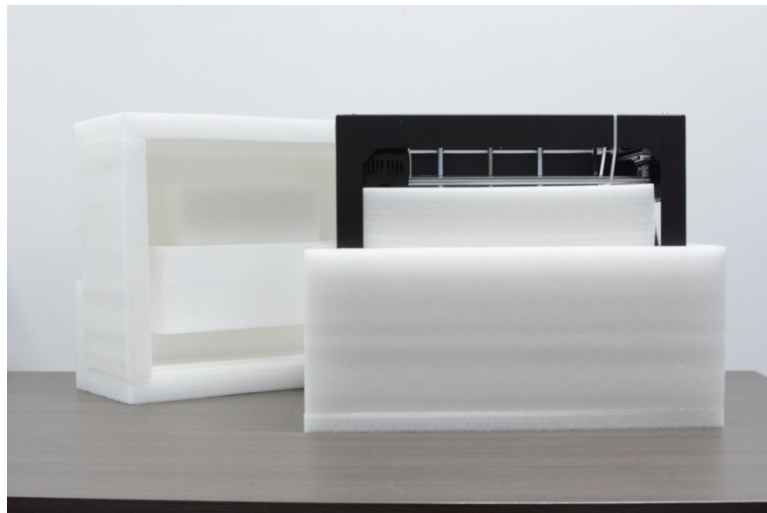

Step3. Take out the accessories from the foam box in order.

Note: The glass is in the second layer of the foam box, please handle with care!



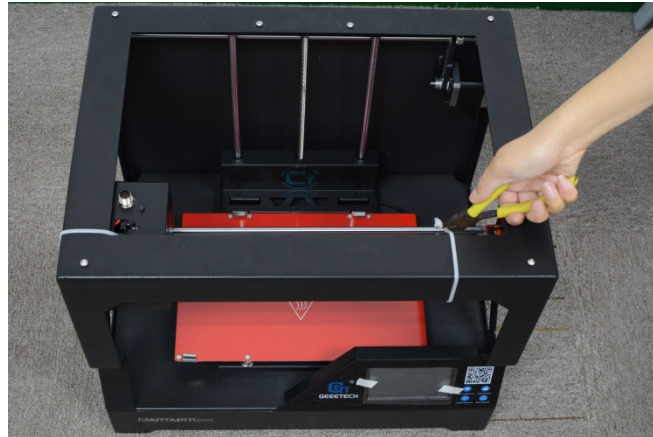

Step4. Remove the foams and cut off the zip ties.



2.2 Accessory Checklist

The accessory tray includes everything you need to use your GiantArm D200, including GIANTARM PLA starter filament and all kinds of software sources etc which enable you quickly to start. If you want to order more filament or purchase spare extruder hotend, please visit www.geeetech.com

Accessories	Picture
Filament spool	
Heat-resistant glass	
Masking tape	
Bowden tube	

<p>Power cable</p>	
<p>USB cable</p>	
<p>Starter Filament</p>	
<p>SD card</p>	
<p>Ejector Pin</p>	
<p>Hotend opener</p>	
<p>Screw driver</p>	
<p>Ball-point pen</p>	
<p>Extruder cable and cable clamp set</p>	

2.3 Printer set up

Step 1. Respectively connect with the two ends of bus wire well, and fix make it on the back of the printer with cable clamp (you can fix the feeding pipe with it together)

Pay attention to the anti-misplug indicator in the aviation connector in case of damaging the pins.







Step2. Fix the filament holder on the back of the printer and then hang the filament on it.



Step 3. Plug the power cable and power the printer on.



Step 4. Click the icon  on the screen to enter the move interface, choose , and then click  to raise the build platform to the middle.

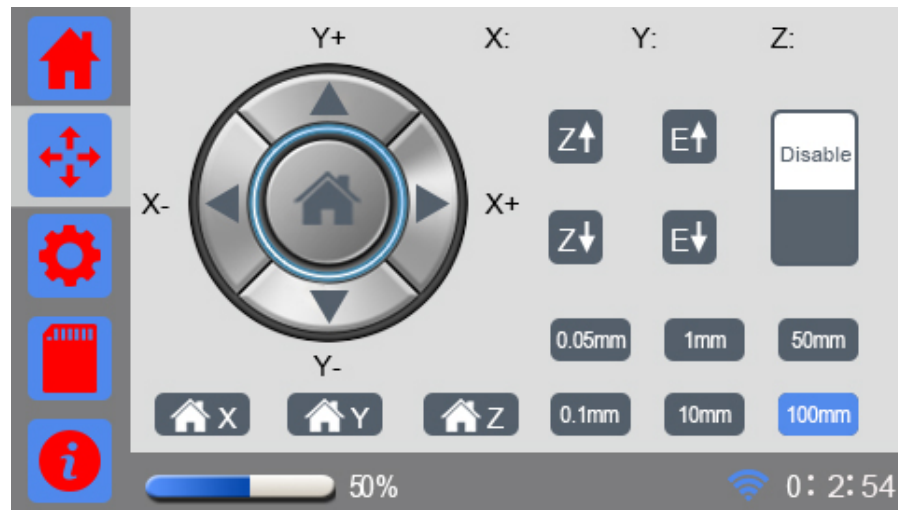

Step 5. Open the two clips on the left and the right of the heatbed, put the glass on the build platform and fix them closely with the clips.

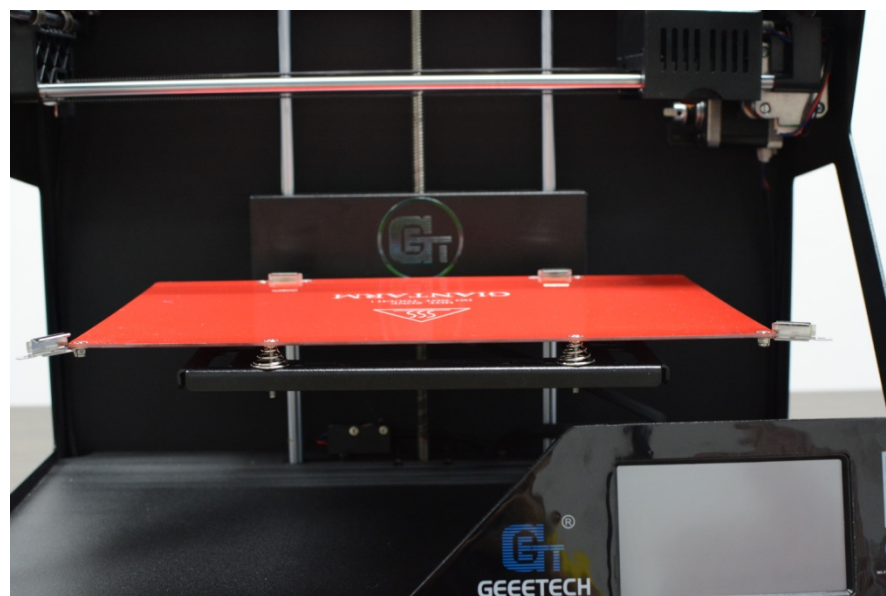

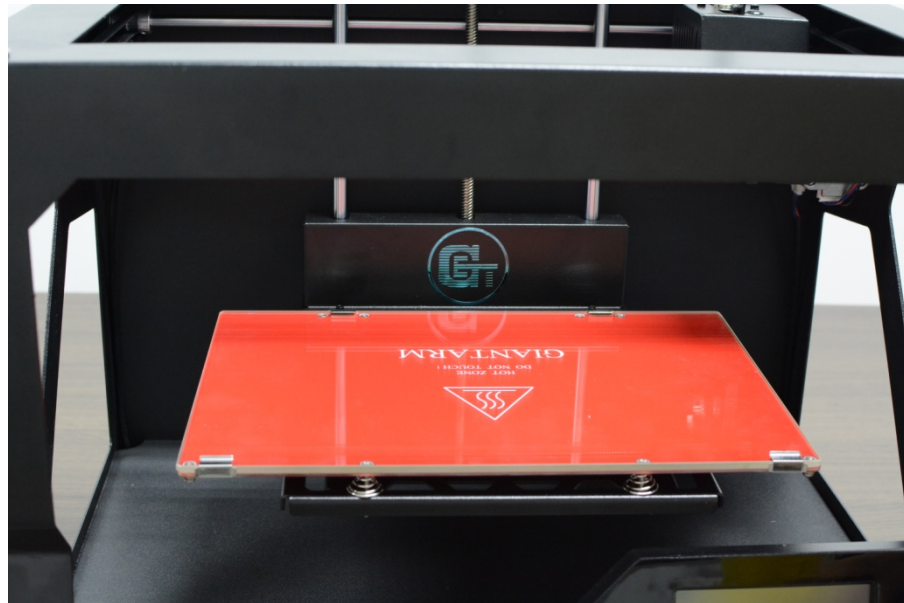





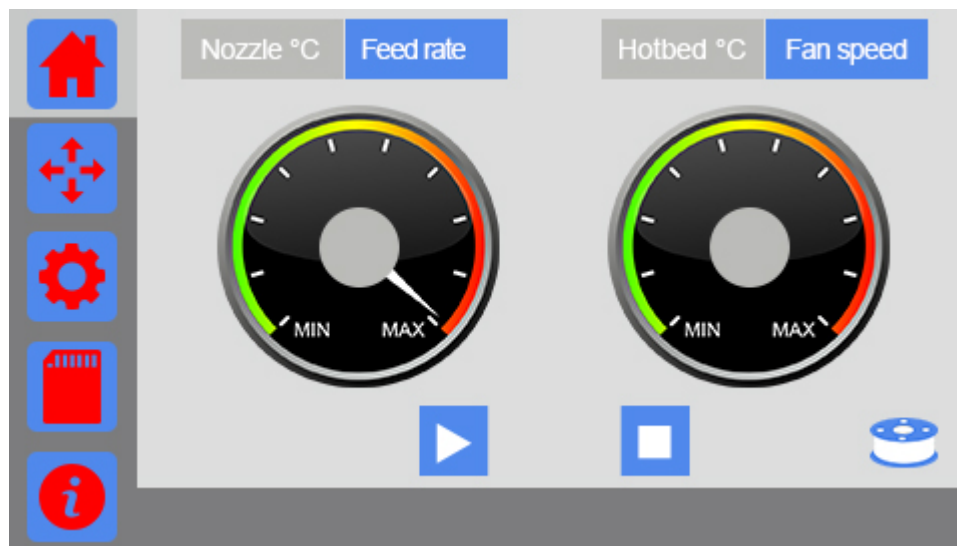

3. GiantArm D200 Control Panel

GiantArm D200 can be controlled via the 4.3" full-color touch screen in the bottom right corner of the printer. Stand-alone printing with SD card and remote control over the printing via EasyPrint App are available.

3.1 Home



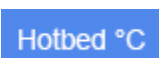
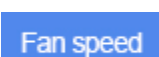





- a.  The icon of the main interface: Click to return to the home interface.
- b.  Printing: click to pause;
- c.  Pause: click to start printing;
- d.  Stop: Click to kill the present printing job;
- e.  Extruder temp: click to read the real-time extruder temperature on the left disk;
- f.  Printing speed: click to read the real-time feed rate on the left disk;
- g.  Hotbed temp: click to read the real-time hotbed temperature on the right disk;
- h.  Fan speed: click to read the real-time fan speed on the right disk.

Note: When printing via USB Serial port, the button [Printing/Pause], [stop] will hide.

3.2 Move



- a.  Move: Choose to enter the Move interface. If there is not any operation within 15s in this interface, it will automatically return to the main interface.
- b.  Home X axis: Click to home the motor of X axis.
- c.  Home Y axis: Click to home the motor of Y axis.
- d.  Home Z axis: Click to home the motor of Z axis.
- e.  Auto home: Click to home the motors of X/Y/ Z axis simultaneously.
- f.  Moving distance: the moving distance of the motor or the length of filament loaded/unloaded per click.

- g.   move X axis:

X-: X axis moves away from the end stop of X axis;

X+: X axis moves towards the end stop of X axis.

- h.   move Y axis:

Y-: Y axis moves away from the end stop of Y axis;

Y+: Y axis moves towards the end stop of Y axis.

- i.  Z axis moves upward away from the end stop of Z axis;

 Z axis moves downward towards the end stop of Y axis.

- j.  Unload filament;

 Load filament.

- k. : Display the current coordinate of X/Y/Z axis.

- l.  Stepper motor Enabled status: once switched into Enabled status, the printer will home first; you

can only move the motor with manual control. Click to disable the stepper motors.



Stepper motor Disabled status: you can move the motor freely with your hand. Click to enable the stepper motors.

Note: The stepper motors are enabled when you power on the printer as default. In idle mode, if there is no operation within 100s, the stepper motors will be disabled autonomously.

3.3 Setting



Click the setting icon and you can observe and set the relevant parameters of the following elements as shown in the picture below.

If there is no operation within 15s, it will autonomously return to the main interface.

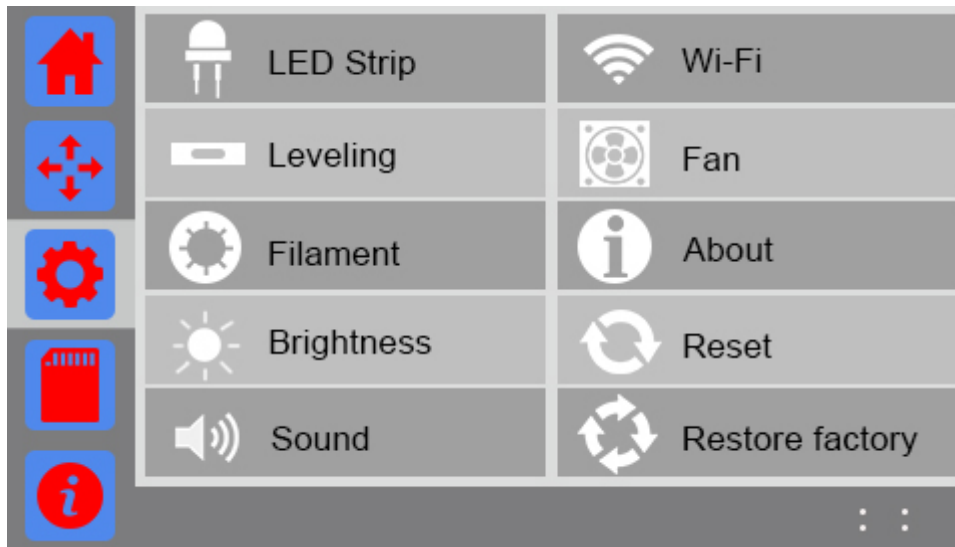

3.3.1 LED light

Select the button of LED strip to set the light color.

If there is no operation within 30s, it will automatically return to the main interface.

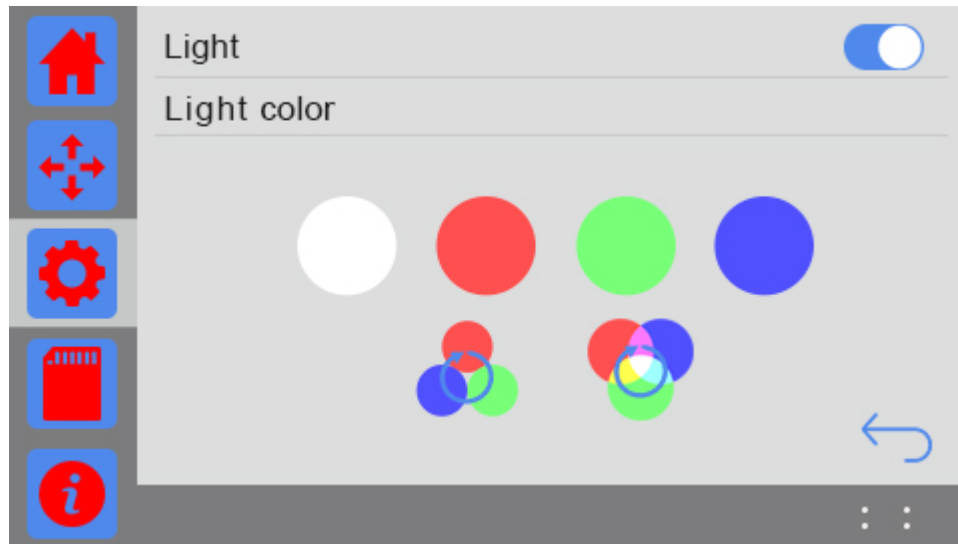

Turn on LED light. The default color is white when you power on the printer.;



Turn off LED light;



Single color mode: Click to choose one of the white/red/green/blue colors as you like.



Pure color flash light: the circulation of three different pure colors - Red, Green and Blue.



Gradual color flash light: the circulation of three different gradual colors of Red, Green and Blue.

3.3.2 Leveling

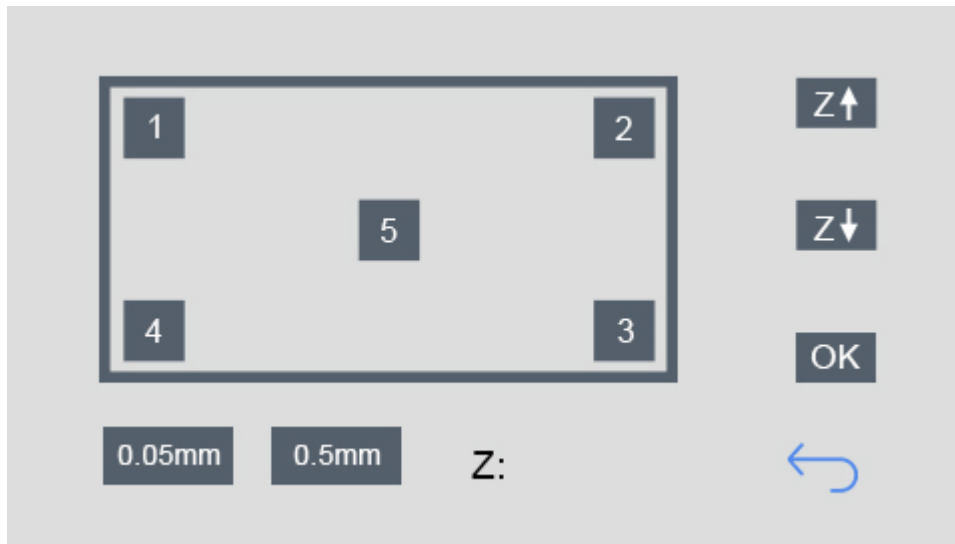

Choose the [Leveling] button to enter the leveling interface. This interface is used for leveling of build platform, as shown in the picture below.



Click to enter the interface, the printer will be homed first and Z axis will rise to 0mm to wait for leveling. Move the nozzle to the five points in turn as shown in the picture to level the platform. During this process, you can use the z+/z- to fine-tune the position of the nozzle. Click [OK] to save the height of the platform.

- Choose Z↑: The hotbed moves upward by 0.5mm and set the coordinate of Z axis at 0mm. The value in the [Z:] is the updated height of the platform.
- Choose Z↓: The platform moves downward by 0.5mm and set the coordinate of Z axis at 0mm. The value in the [Z:] is the updated printing height.
- Click [OK] to save the updated height of the platform.
- Choose [1]: The platform moves downward by 10mm and the nozzle moves to the [1] point. Then the platform moves upward to 0mm (the original coordinate of Z axis).

By that analogy, you can level the platform at the other 4 points.

- Choose  to return to the main interface of [settings]. At the same time, the motors will be homed.
- : Displaying the real-time height of the platform.

(Note: You can finish the leveling job of the 5 points out of sequence)

3.3.3 Filament

Choose the [Filament] button to set the relevant parameters of filament, you can set the default temp of the extruder and hotbed, direct control over the filament detector and change filament in the half way.

If there is no operation within 30s on this interface, it will automatically return to the main interface.

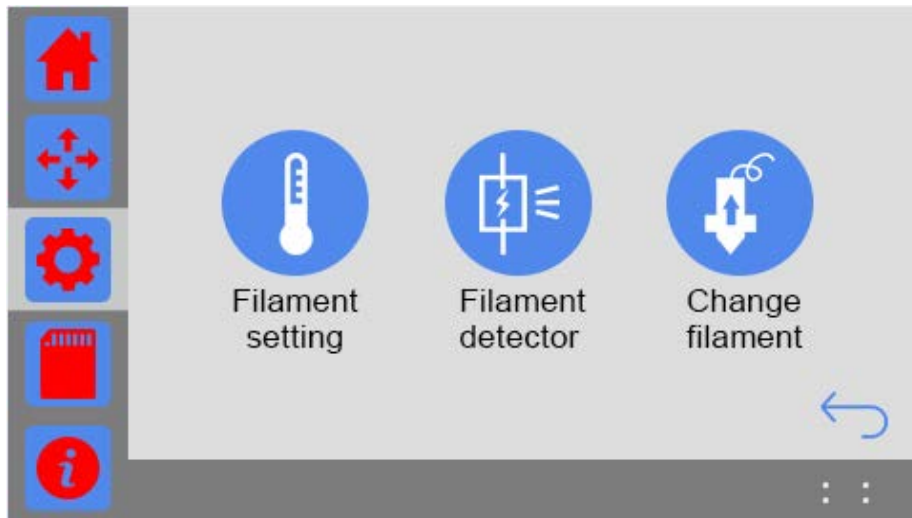

1. Setting the default temp: Click  to set the default temp of the extruder and hotbed as shown in the picture below. If there is no operation within 30s on this interface, it will automatically return to the main interface.

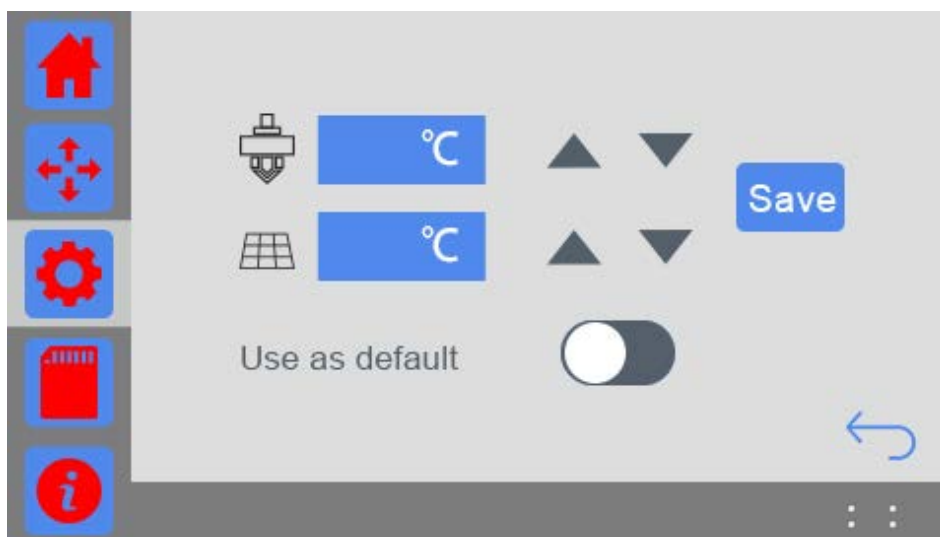

For the same G-code file, the user can set different target temp of the extruder and the hotbed with different type of filament. When using this function, the printing is not influenced by the temperature value of the G-code slicing setting but by this final setting.

Turn on the **default temp setting**. Click the blue textbox to enter the temp value or click or long press the button to set the suitable printing temperature for the filament .After finishing setting, you need to click  button to save your setting.





2. **Filament detector:** Click the icon  to choose turn on/off the Filament detector.

If there is no operation within 30s on this interface, it will automatically return to the main interface, as shown in the picture below.

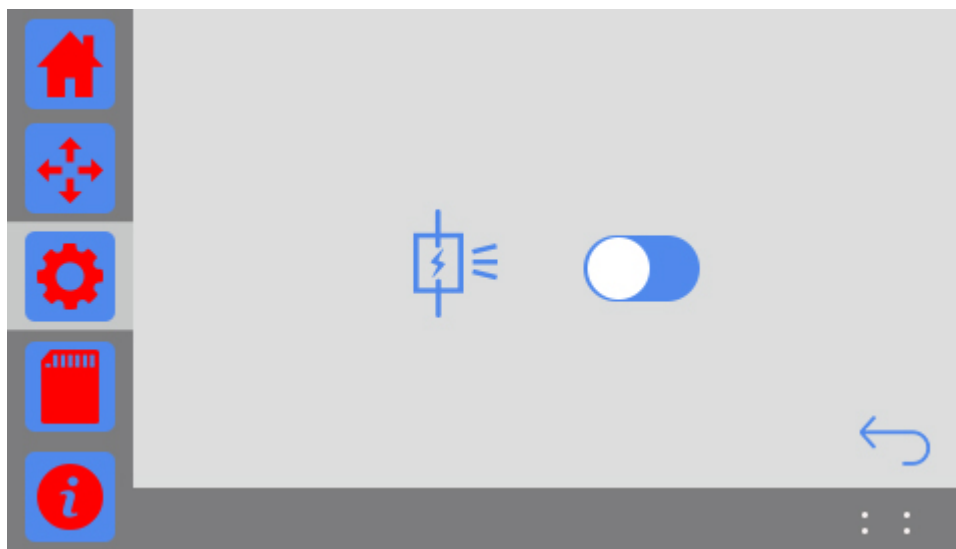
For more detailed information, please make reference to [7.2 filament detector](#).



 Turn off the filament detector;

 Turn on the filament detector;

Turn on to activate the detecting system. When the filament is detected, the main panel will show the filament icon, as shown in the picture below.

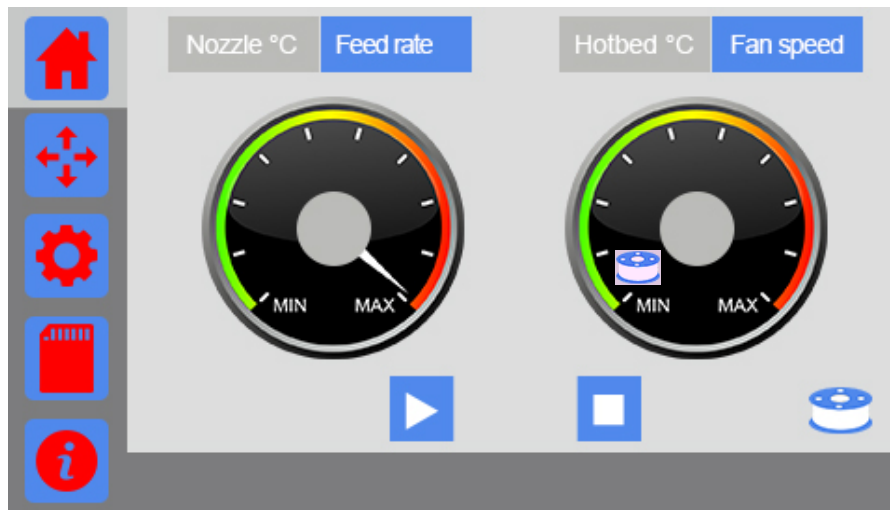

If the system detects an abnormal signal of filament, either filament fracture or outage, the icon will

turn into , as shown in the picture below.

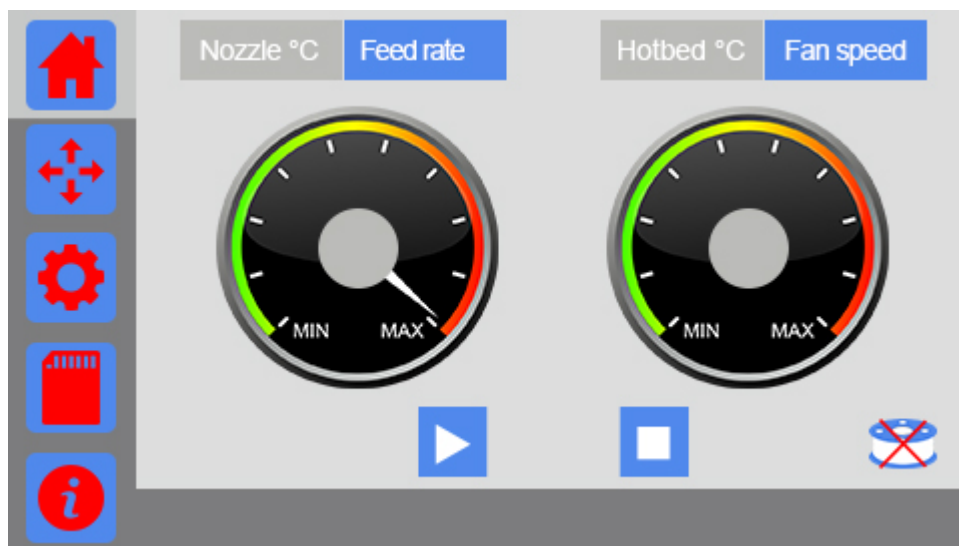

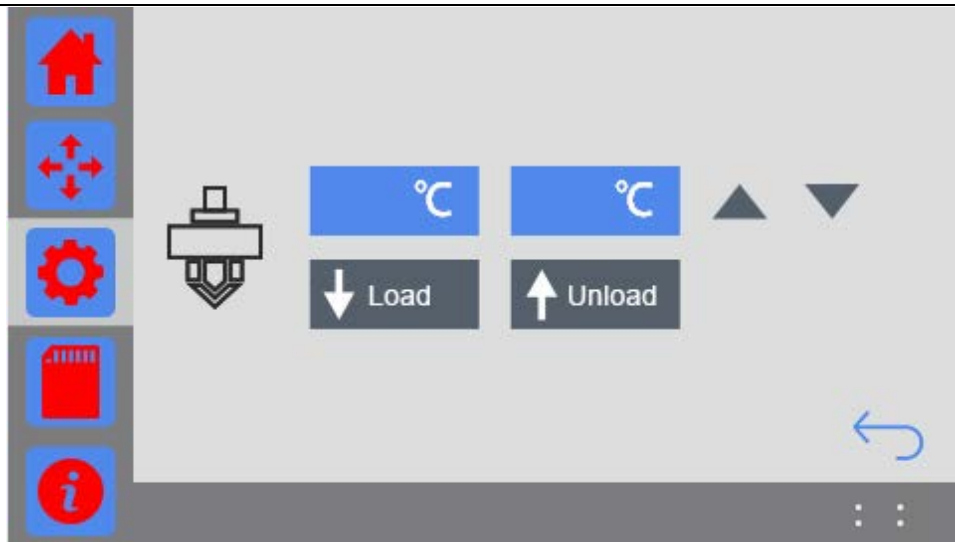

3. Change filament: Click  to enter the interface of changing filament as shown in the picture below. If there is no operation within 30s on this interface, it will automatically return to the main interface.



- a. The blue textbox on the left shows the real-time temp of the extruder, and the one on the right shows the target temp. You can modify the target temp by clicking the textbox or adjusting the arrow button.

- b. Click , the red slash will disappear and the extruder will start to heat.

- c. : When the temperature of extruder reaches its target value, click *Load* and the filament is extruded out by 10mm per click.

- d. : When the temperature of extruder reaches its target value, click this *Unload* and the filament will be retracted back by 10mm per click.

3.3.4 Brightness

Choose [Brightness] icon to enter the touch screen backlight setting interface and set the brightness of the touch screen. The default value is 80%. If there is no operation within 30s on this interface, it will automatically return to the main interface, as shown in the picture below.

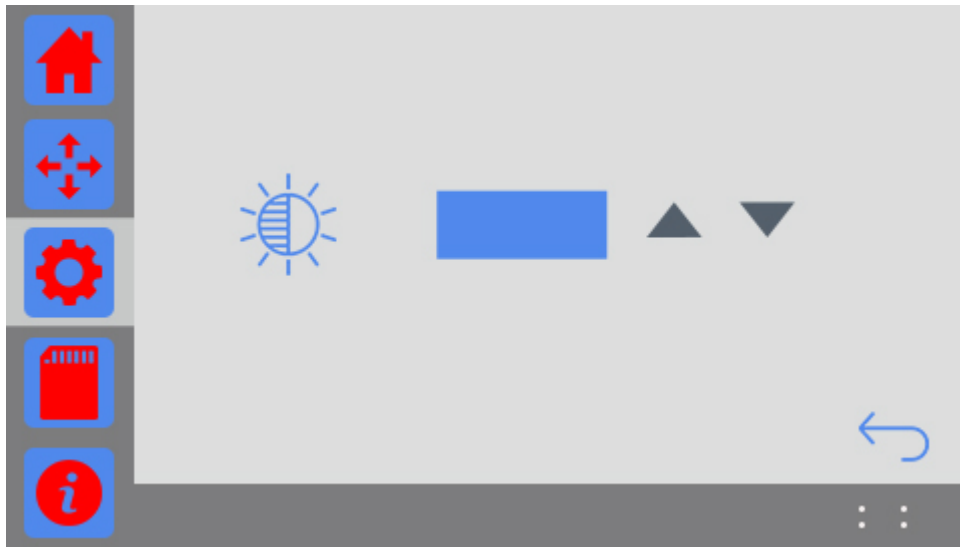

▲ Increase: Click this button to increase the brightness by 1% per time (MAX= 100%). Long press ▲, the brightness keeps increasing until it reaches 100%.

▼ Decrease: Click this button to decrease the brightness by 1% per time (MIN= 10%). Long press ▼, the brightness keeps decreasing until it reaches 10%.

3.3.5 Sound

Choose [Sound] button to enter the interface of sound setting and set the buzzer sound of the printer when it is running. If there is no operation within 30s on this interface, it will automatically return to the main interface, as shown in the picture below.

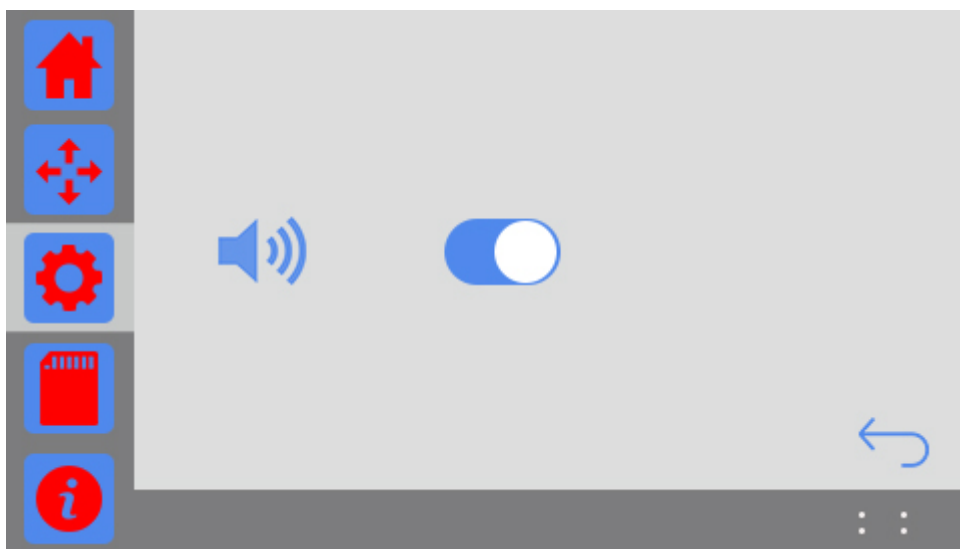

Buzzer sound switch: when the printer is powered on, the sound switch is open by default.



Buzzer sound turns off;



Buzzer sound turns on.

3.3.6 Wi-Fi

When you use EasyPrint App to remote control GiantArm D200, it is necessary to configure App and the printer. (Make reference to [6.3 Print via Wi-Fi](#))

Choose the [Wi-Fi] icon to enter the Wi-Fi setting interface as shown in the picture below. If there is no operation within 30s on this interface, it will automatically return to the main interface.



- a. Wi-Fi switch: Click this button to turn on /off Wi-Fi.
- b. Connect autonomously switch: The status of this switch can be saved when the printer is cut out. After the printer is on and the button [connect automatically] turns on, if detecting Wi-Fi, the printer will be automatically Wi-Fi connected.
- c. The *set* button for SSID: Click it to configure Wi-Fi with APP.
- d. SSID: Showing the name of the hotspot.
- e. IP address: Showing the IP of hotspot configuration. If the Wi-Fi is disconnected; the Wi-Fi icon turns grey; if the Wi-Fi is connected, when the Wi-Fi icon turns blue; if Wi-Fi turns off, there is no Wi-Fi icon.
- f. Server: Showing the IP of the server. If the Wi-Fi is disconnected; the Wi-Fi icon turns grey; if the Wi-Fi is connected, when the Wi-Fi icon turns blue

3.3.7 Fan

Choose the [Fan] icon to enter the interface and adjust the fan speed, as shown in the picture below. If there is no operation within 30s on this interface, it will automatically return to the main interface.

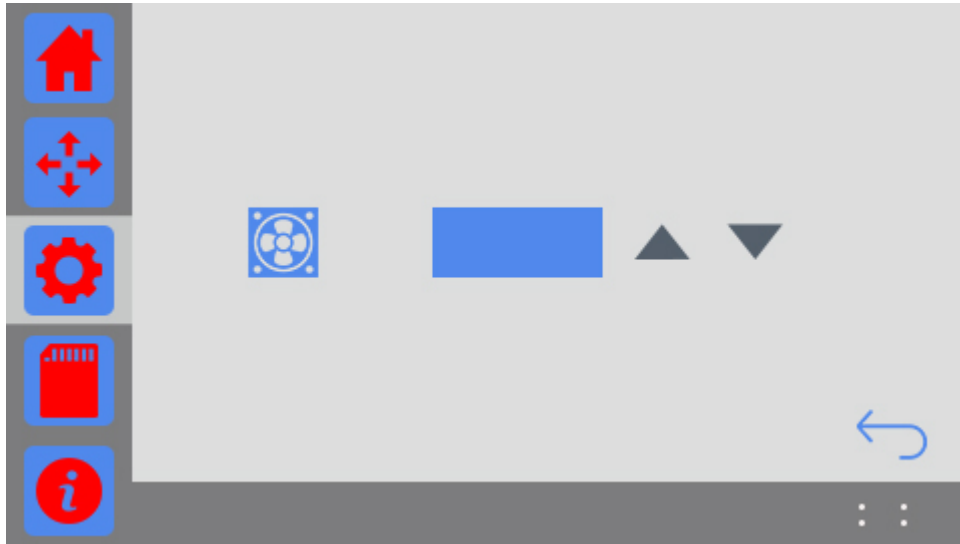

▲ Increase: Click this button to increase the fan speed by 1 per time (MAX= 100). Long press ▲ , the speed keeps increasing until it reaches 100.

▲ Decrease: Click this button to decrease the fan speed by 1 per time (MIN= 0). Long press ▼ , the speed keeps decreasing until it reaches 0.

3.3.8 About

Choose [About] icon to enter the interface of the information of device and view more information about GiantArm D200, as shown in the picture below.

If there is no operation within 30s on this interface, it will automatically return to the main interface.

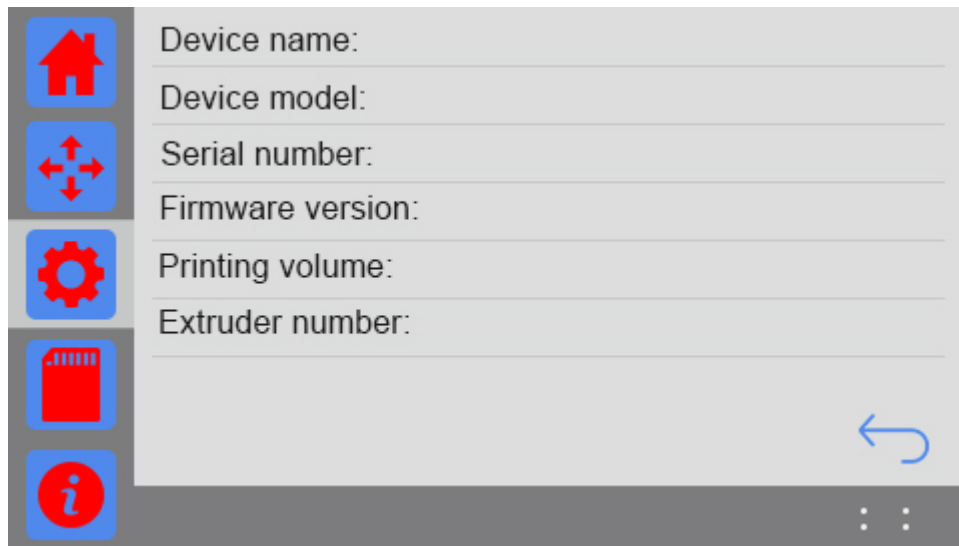

3.3.9 Reset

Choose [Reset] icon. The prompt dialog box will pop up, as shown in the picture below.

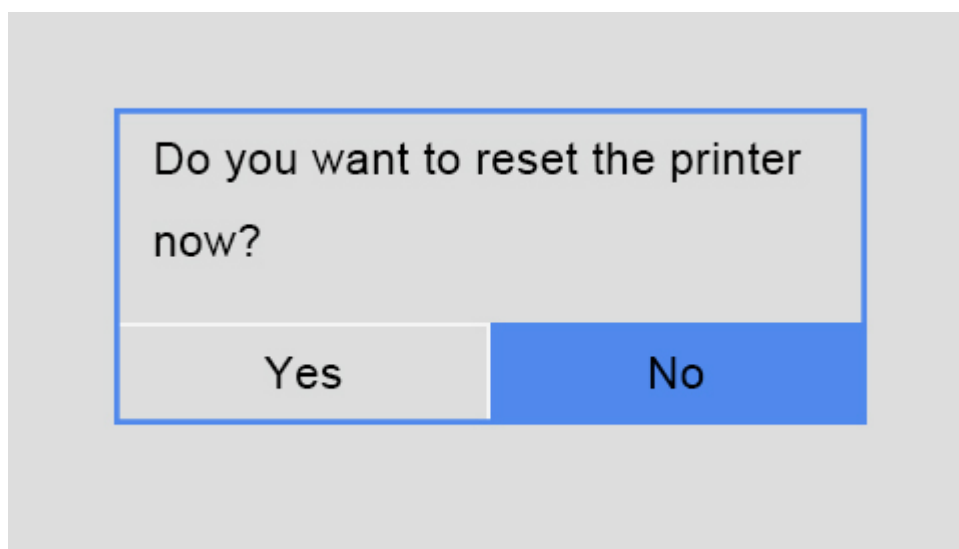

- a. Choose [Yes]: The printer will save the current printing status during SD card printing, Wi-Fi printing, or when the printing job is paused. And then the printer will reset. Otherwise it will reset directly.
- b. Choose [No] to return to the [Settings] interface.

3.3.10 Restore Factory

Choose [Restore factory].

This function is disabled when the printer is running.

When the printer is not printing, a window will pop up, as shown in the picture below.

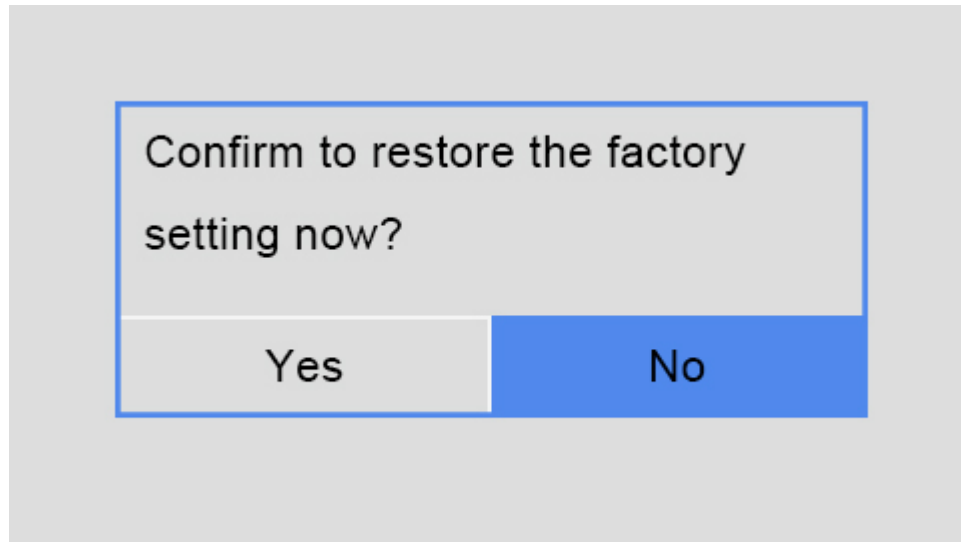

- a. Choose [Yes]: Restore factory settings and restart the printer.
- b. Choose [No]: Return to [Settings] interface.



3.4 Print from SD Card

Choose SD card icon to view the 3D model files saved in the SD card. GiantArm D200 is compatible with three file formats: .gcode, .GCO, .gco.

If there is no operation within 15s on this interface, it will automatically return to the main interface.

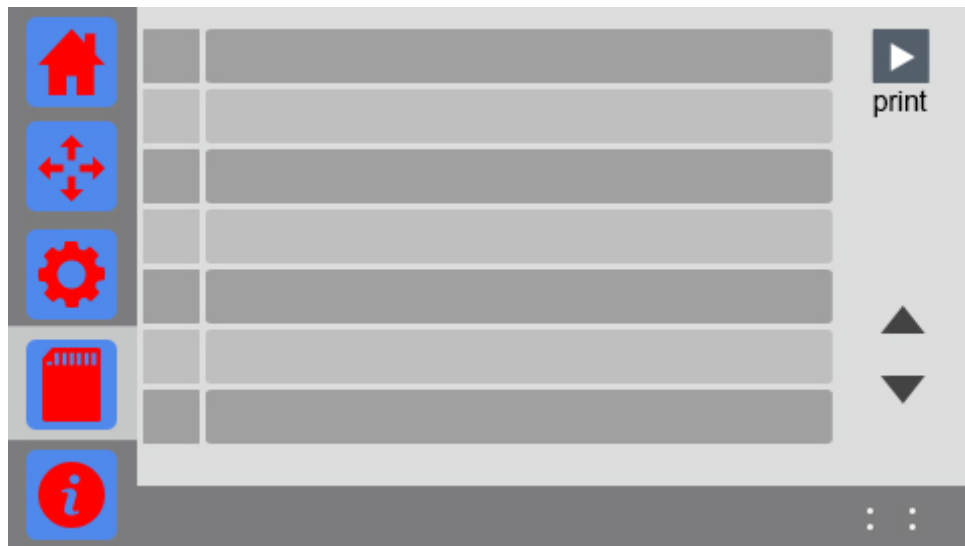
The following picture shows the SD card interface.



- a.  : Select one file and click this button to start printing.
- b.  : Page up.
- c.  : Page down.
- d. File name: Showing the .gcode, .GCO, .gco files in SD Card., click it to choose the file.
- e. Check box: Mark the chosen file.

[How to generate G-code file? Please make reference to 6.2 Print via USB Serial Port\)](#)

3.5 Information

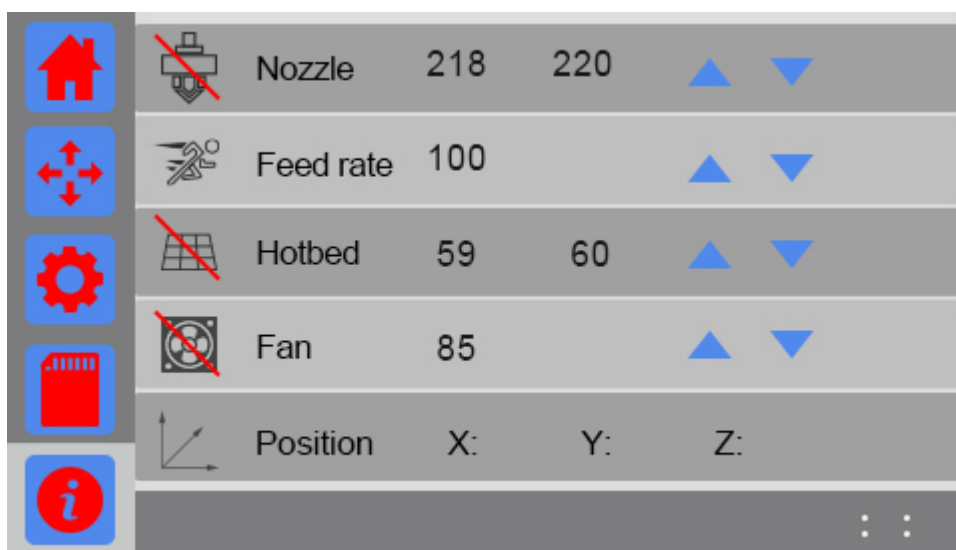



Click  to enter the interface of Information and view the real-time printing status.

1. The temperature of the nozzle:



Click the icon to start heating the extruder. The icon turns into .

As shown in the above picture, "218" and "220" respectively means the current temperature of the nozzle and the target temperature of the nozzle.

Click the number to pop up the small keyboard to set the temperature, or click /long press the arrow button to set the temperature.

2. Feed rate:



As shown in the above picture, "100" means the current temperature of the feed rate. Click the number to pop up the small keyboard to set the feed rate, or click/ long press the arrow button to set the feed rate.

3. The temperature of hotbed:



Click the icon to start heating the hotbed, and the icon turns into .

As shown in the above picture, "59" and "60" respectively means the current temperature the hotbed and the target temperature of the hotbed.

Click the number to pop up the small keyboard to set the temperature, or click/ long press the arrow button to set the temperature of the hotbed.

4. Fan speed



Click the icon to activate the fan, and the icon turns into .

As shown in the above picture, "100" means the current fan speed.

Click the number to pop up the small keyboard to set the fan speed, or click/long press the arrow button to set the Fan speed.

5. Axis



Display the current coordinate of X/Y/Z axis.

3.6 Status Bar

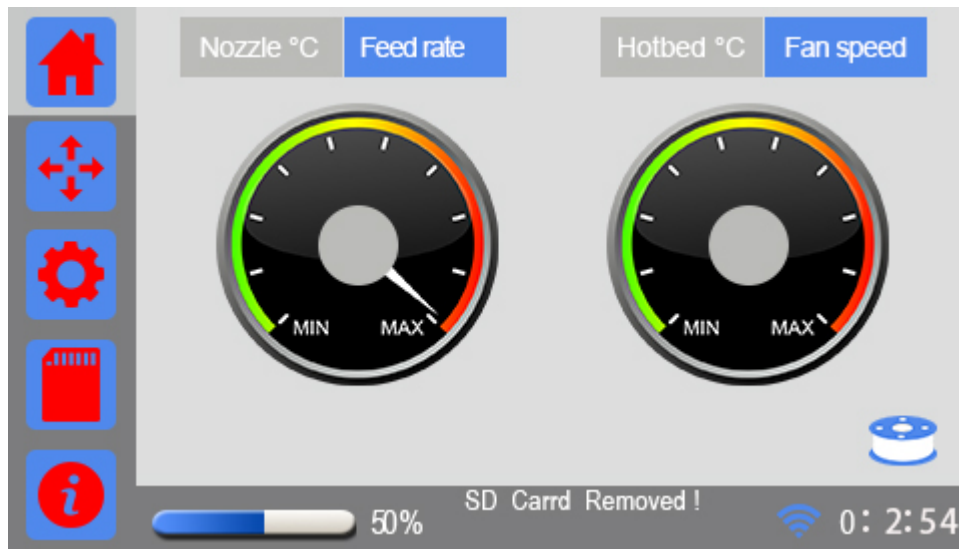

a. Printing status

Printing status includes printing progress bar and progress value, ranging from 0~100%, as shown in the picture below.



b. prompt message

Here you can check the status of your printer.

Triggering events	prompt message
Not detect SD card	SDCard Removed!
Detect SD card	SD Card OK!
Serial port printing (display the left printing time)	Eg: ETE XXh XXm XXs
Display the printing files for the printing of SD card and APP	Eg: SD1: /papa-noel.gcode
Display the printing time of finishing printing the model	Eg: XXHours XXMinutes

C. Wi-Fi icon

The status of Wi-Fi icon indicates different connection information.

- ① If Wi-Fi is turned off. The Wi-Fi icon will disappear.
- ② If Wi-Fi is turned on but not connected. The Wi-Fi will turn white;
- ③ If Wi-Fi is turned on and connected, the Wi-Fi icon will turn blue.

3.7 Other information

During heating, in the case of temperature changing abnormally or temperature surpassing a maximum of 30 degrees, you will see the following message:

If the printer is printing via serial port via USB connection, you need to manually stop the current printing job;

If it is printing via SD card or Wi-Fi, the printer will stop automatically.

Then you need to check the corresponding heating elements. It may be caused by a poor connection.

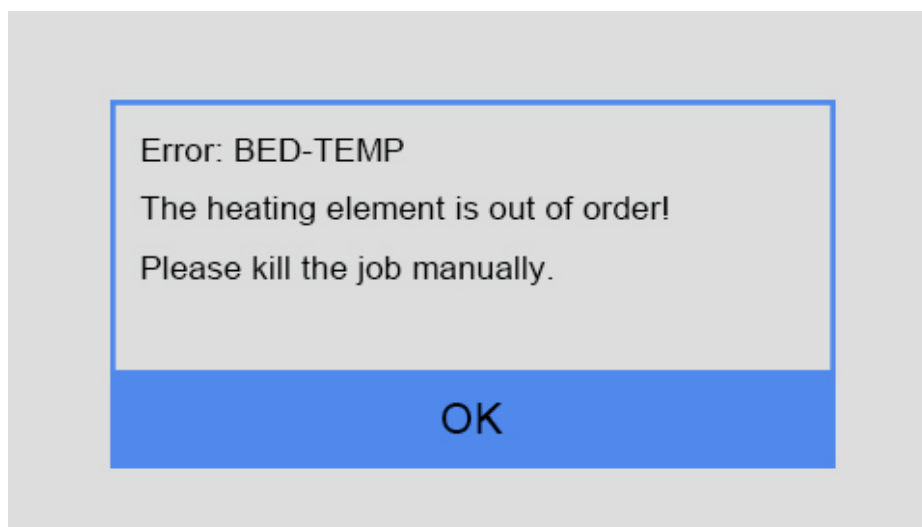

(printing via serial port)

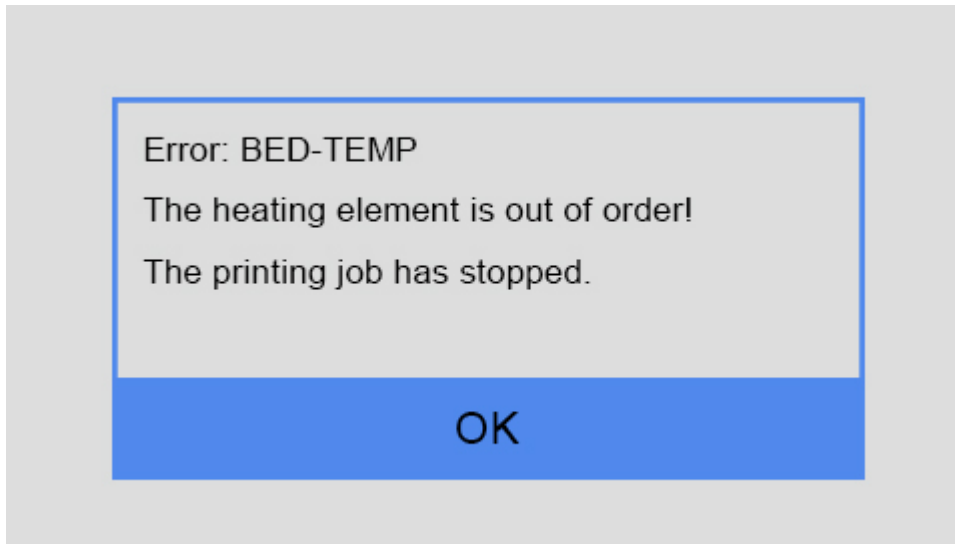

(printing via SD card or Wi-Fi)

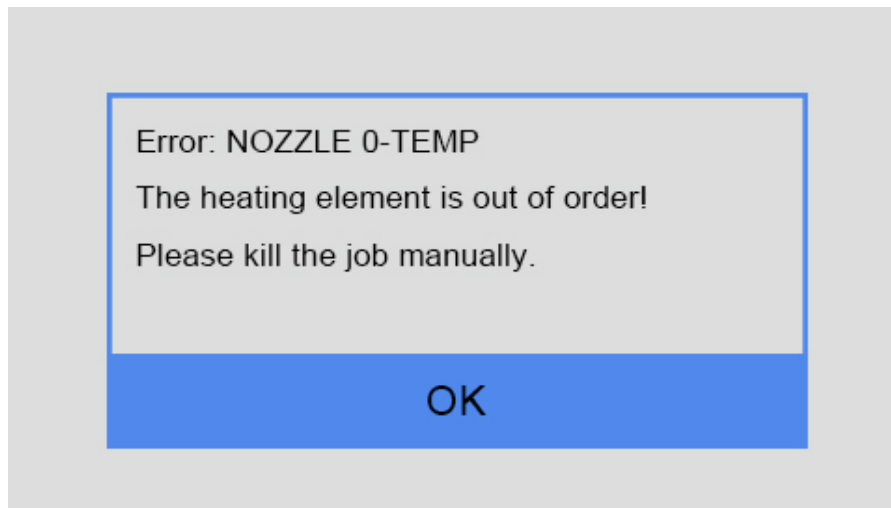

(printing via serial port)

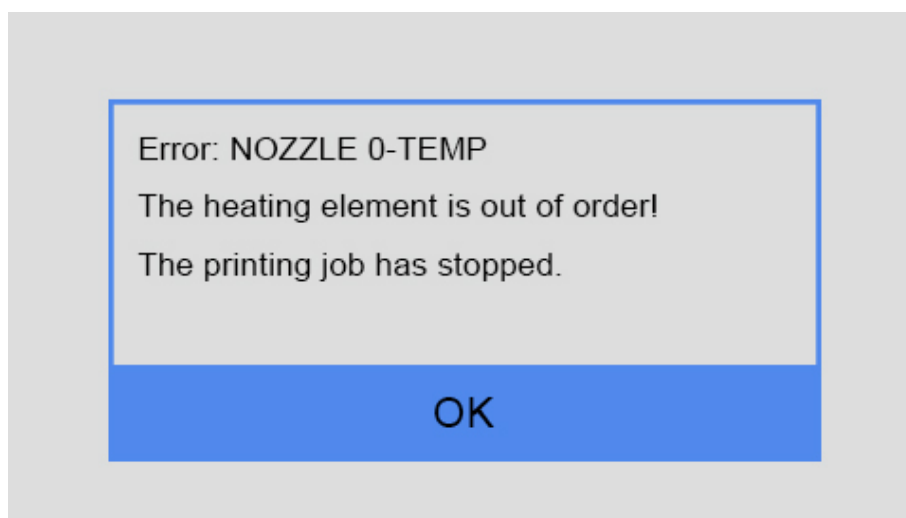

(printing via SD card or Wi-Fi)

4. Leveling

Leveling the build platform is very important to the printing quality. Before printing, we need to do hotbed leveling to ensure the close adhesion between the print models and build platform to prevent the collision between the nozzle and the build platform. You need to slightly adjust the height of the build platform before your first printing. Please fine-tune the vertical distance between nozzle and hotbed. 0.1mm is the optimal value (almost the thickness of a piece of A4 paper).

Note: Before delivery, we have leveled the build platform. Generally speaking, you can directly print. Although we make the bundled-up packing to GIANTARM D200, the build platform may still incline a bit during the shipping. To ensure the best printing effect, we suggest that you do the tests and calibration job according to the following instruction.

4.1 Coarse tuning

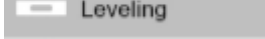
Step 1. Choose the button [Leveling]  on the setting interface to enter the "Leveling", meanwhile the printer will home firstly, then Z axis will rise to 0mm to wait for leveling.

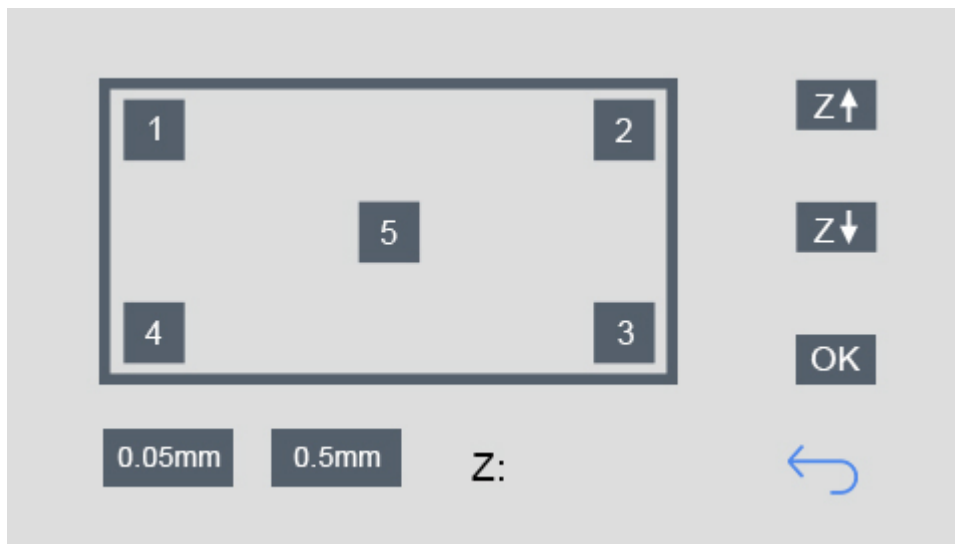

Step 2. Click the leveling point [5], the extruder will move to the middle of the build platform. You can observe the distance between the nozzle and the platform.

- If there is an obvious gap, it means the distance between the nozzle and the build platform is too far, the extruded filament will not be closely attached to the build platform. In this case, please click  to upraise the build platform to reduce the distance between the extruder and the build platform until there is only a little gap between the nozzle and the build platform, and then click the button [OK] to save the current printing height.

- If you can't see any gap, it means the distance between the nozzle and build platform is too close. The filament can't be extruded out or can even be jammed, In this case, please click  to lower the build platform to increase the distance between the nozzle and build platform until you can see a little gap between the nozzle and the build platform, then click the button [OK] to save the current printing height.

- During this process, you can use the z+/z- to fine-tune the height of the platform.
- You can choose to move 0.5mm/0.05mm per click.
- Click [OK] and save the printing height of Z axis.

4.2 Fine tuning

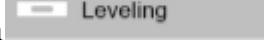
Step1. Choose [Leveling] icon  to enter the interface to start to level the hotbed. Meanwhile the motors will be homed and Z axis will rise to 0mm.

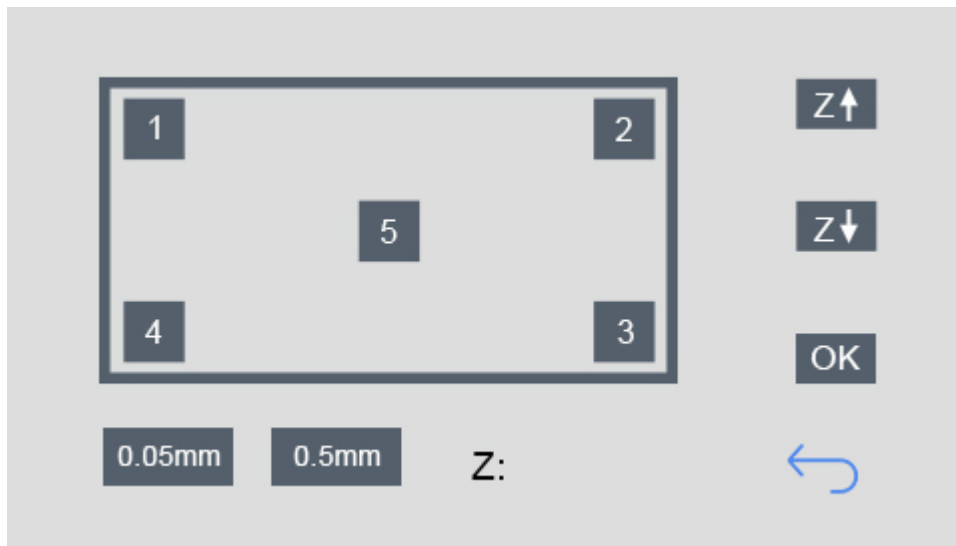

Step 2. Click the leveling point 1, the extruder will move to the first point. Put a piece of A4 paper between the nozzle and hotbed. Slide the paper back and forth. Stop when you feel the nozzle just start to grab a little bit.

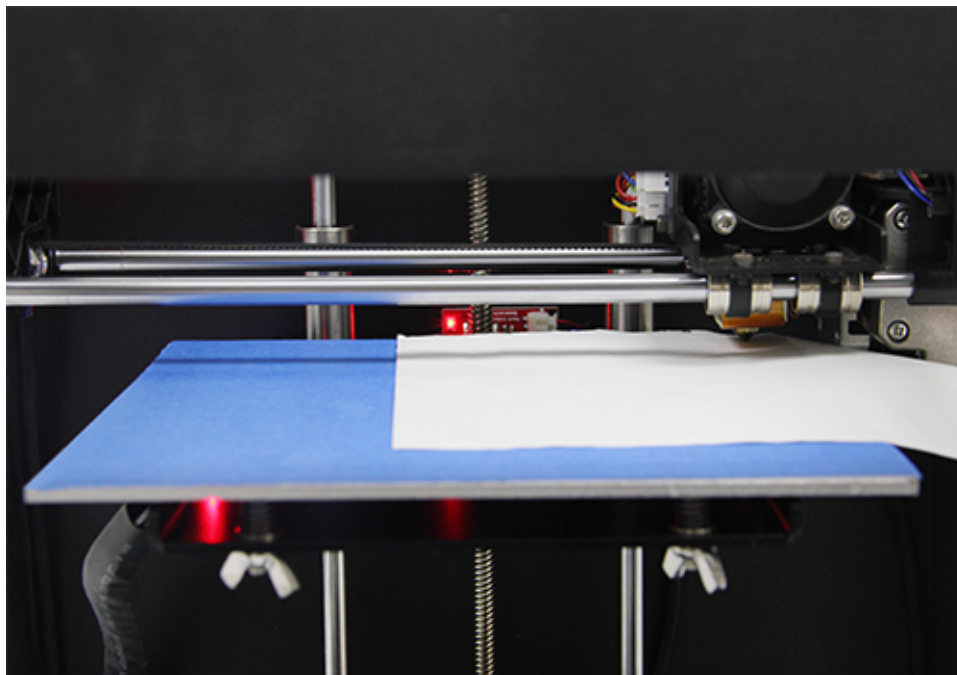

If you cannot feel a little bit friction at all, it means the distance between the nozzle and build platform is too far and the adhesion of filament to the hotbed will be not guaranteed. You need to anticlockwise rotate the nut in the bottom of the hotbed which is corresponding to leveling point 1 and make the build platform raise up to reduce the distance between the nozzle and the build platform.

If you can feel a big amount of friction, it means the distance between the nozzle and build platform is too close. The filament can't be extruded out or can even be jammed. You need clockwise rotate the nut in the bottom of the hotbed which is corresponding to leveling point 1 and make the build platform drop off to increase the distance between the nozzle and the build platform.

Step3. Move the extruder to the other 3 screw and adjust the screw until you get the same amount of friction as you felt with the first one. Once you have adjusted each of the three screws, go back and check each one again, since adjusting one screw can affect another. You shouldn't need to go around the bed more than twice.

After leveling, the filament should be fully extruded with smooth lines and closely stick to the platform, as shown in the picture below.

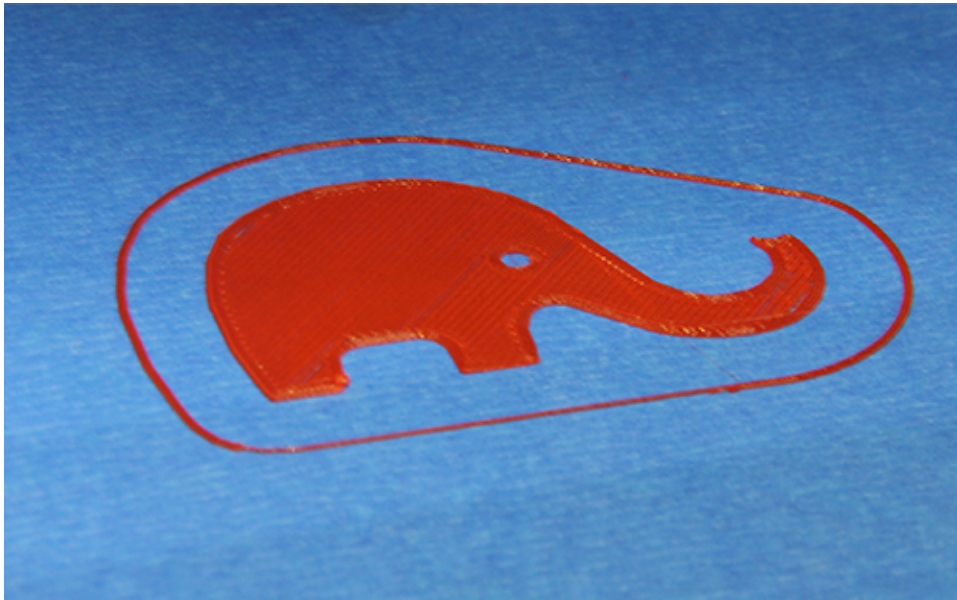

Notes:

- i. When you finish leveling job, we recommend you test the build platform again to ensure the satisfying leveling.
- ii. When the printer is violently shaken during shipping and moving, the height of the build platform may be affected. You need readjust the leveling.
- iii. When there is the wrapping, curling or after you dismount the extruder, please readjust the leveling.
- iv. After restoring factory settings, we suggest you check the height of the nozzle and platform.

5. Load filament

GIANTARM D200 is compatible with filaments including ABS, PLA, flexible PLA, wood-polymer, PVA, HIPS, PETG, etc. Since different filament requests different temperature, please set temperature of the extruder and hotbed according to the filament factory's proposal.

Step 1. Setting>Change filament. On this interface, you can preheat the extruder ([the detailed function, please see the part Change Filament of 3.3.3 Filament](#))

Here you can set the target temperature. Click the switch button of extruder to start preheat.

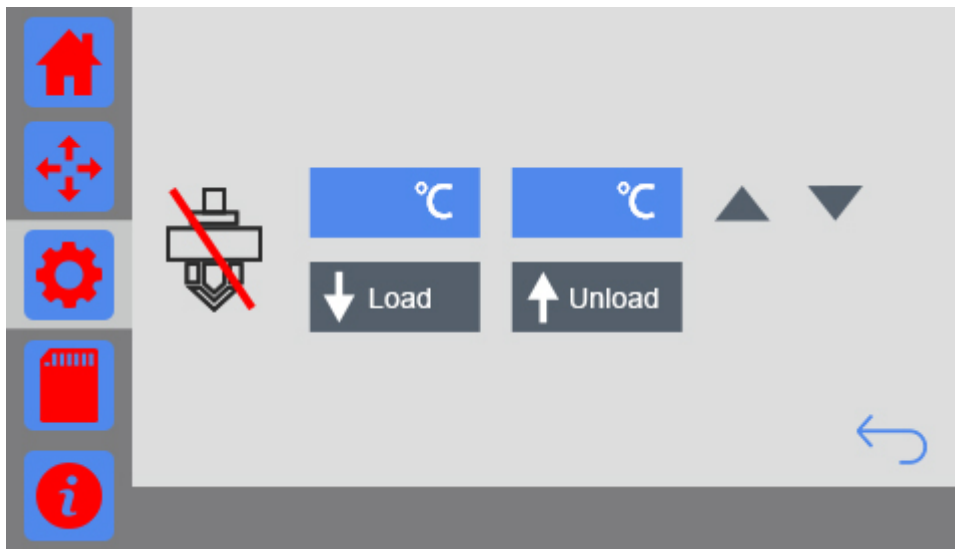

Step2. Thread the filament through the filament detector, and then pass the feeding pipe to reach the feeding port.



Step3. Sharpen the front part of filament by scissors. Press the lever bar with one hand, and insert the filament into the tube of at the very bottom of the extruder barrel with the other hand. Please ensure the filament reach the very bottom of the feeding port/ extruder barrel.

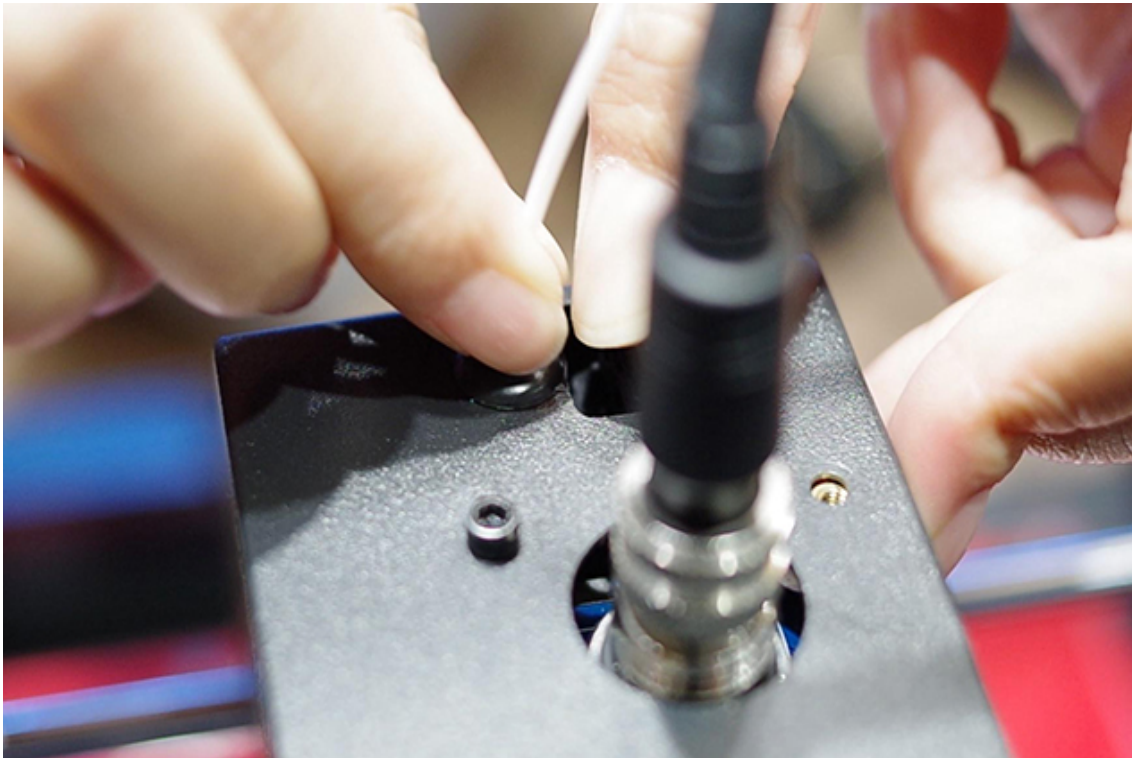

Step 4. Once the extruder reaches the target temperature; click the button  on the screen. The hand holding the filament can obviously feel the grab from the extruder motor. Long click the button “Load” until you can see the filament be extruded out smoothly from the nozzle.

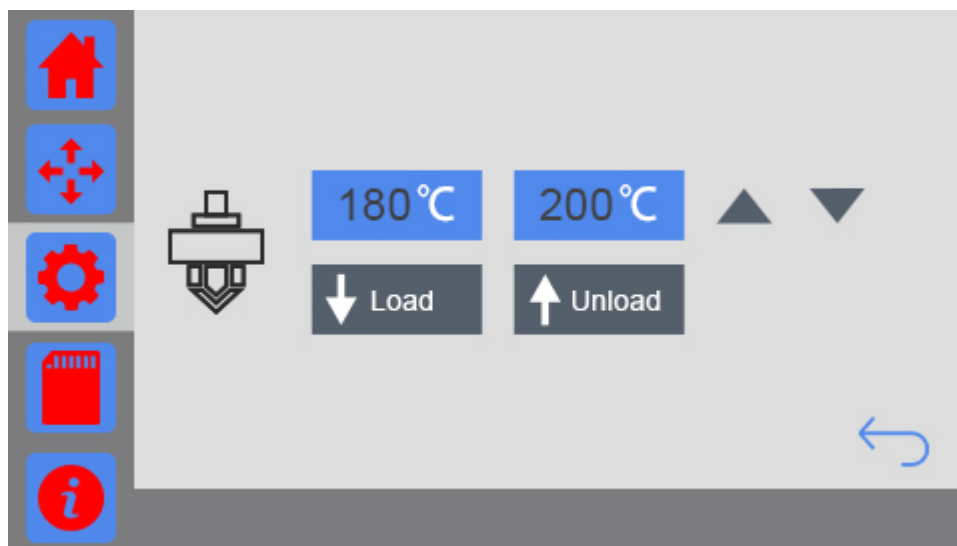

If the extruder cannot normally work or the feeding is not fluent, [please make reference to FAQ.](#)

6. Start to print

After finishing leveling and loading filament, you've finished all the preparation work. The next step is to print! GIANTARM D200 supports 3 ways of printing: Print from SD card, Print from USB serial port and Print from APP (with Wi-Fi). You can download models from Internet to make the printing. Of course, you can also design the creative objects by yourself for your printing.

6.1 Print from SD card

The easiest way is to print from SD card. GIANTARM D200 supports printing files in the following formats: .gcode, .GCO, .gco. Please ensure the file is saved in the root directory of SD card, otherwise the printer will not detect it.

Step 1. Insert the SD card with the .gcode files into the slot on the left side of the printer. Click the SD card icon to enter the interface of SD card, as shown in the picture below.

Step 2. Click to choose the file you want to print and it will be marked with a tick in the check box;

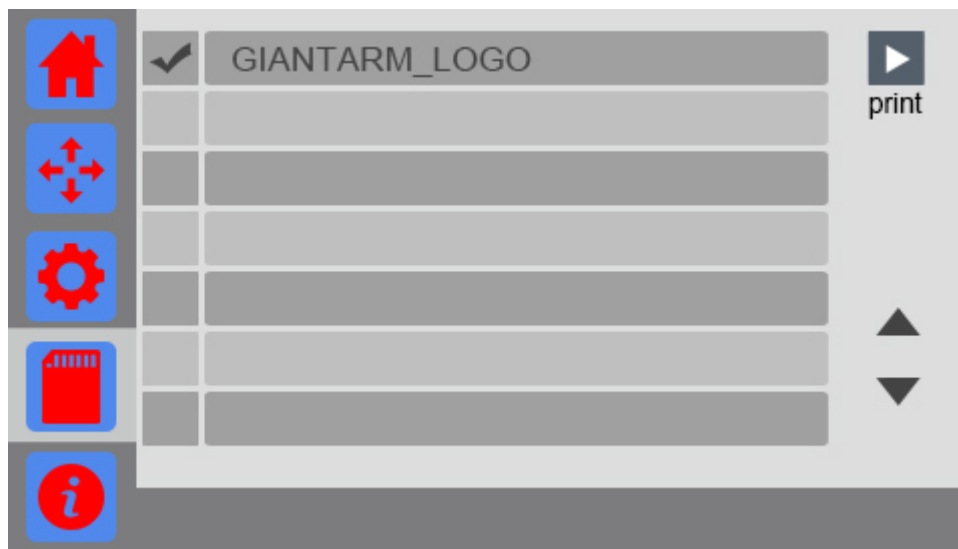

Step 3. Click the button "Print" and start to print. The page will automatically skip to the main interface.

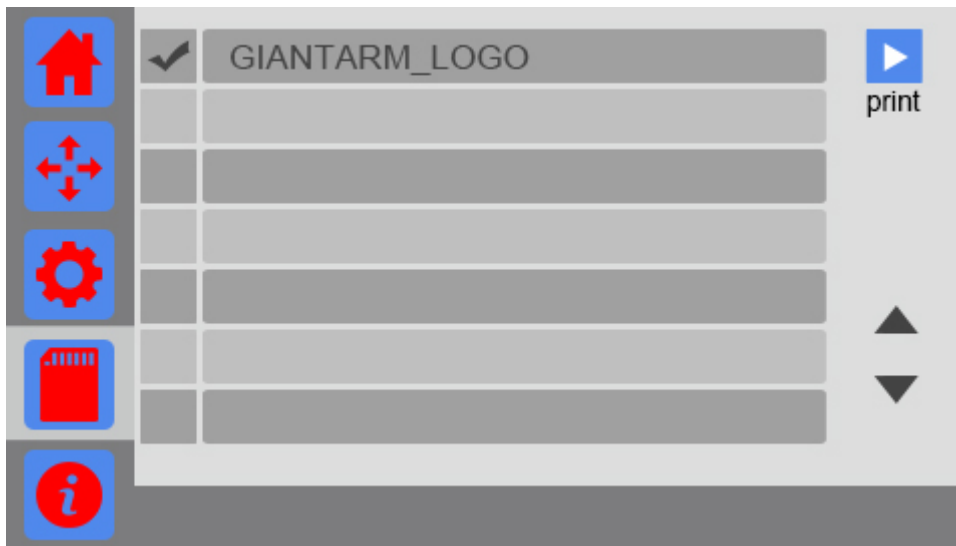

Upon printing, the printer begins to heat up the extruder and the heatbed. On the main interface you can see the relevant printing status on the round disk. When the temperature reaches the target value, the printer will automatically start to print.

6.2 Print via USB Serial Port

GIANTARM provides the 3D printing control software **EasyPrint 3D** which is specially designed for GIANTARMD200. EasyPrint 3D supports the model files, including **g.code**, **.stl**. The software integrates 3D printer control and slicing. With intuitive user interface and convenient operation flow, it can cater for different printing requests for both entry-level user and expert users alike.

For the detailed user introductions of EasyPrint 3D, please make reference to EasyPrint 3D.

<http://www.geeetech.com/specialpage/software/>

6.2.1 EasyPrint 3D Installation and Configuration

Step 1. Install the driver

Power the GIANTARM D200 up and connect it to computer with the USB cable, the driver will be installed automatically. After installation, you can enter Device manager and find the USB Serial Port which is the communication port for the printer and computer.

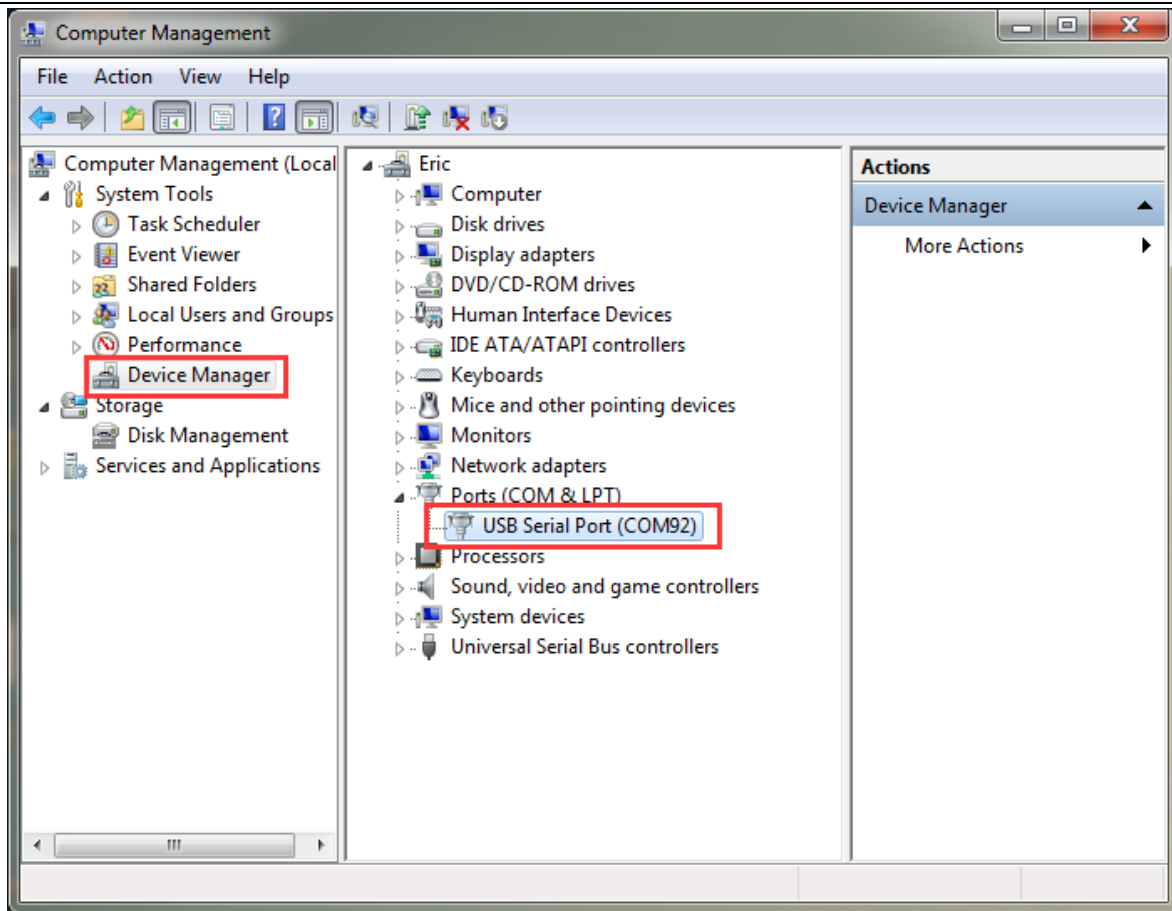

If the driver cannot be automatically installed, please download the [FTDI](http://www.ftdichip.com/Drivers/VCP.htm) (<http://www.ftdichip.com/Drivers/VCP.htm>) or find it in the SD card and then manually install it.

Note: the COM port varies every time.

Step2. Install EasyPrint 3D

You can find EasyPrint 3D software in the SD card, or you can download it here: <http://www.geeetech.net/firmware/EasyPrint.msi>. Then finish the installation following the installation wizard.

Step 3.Start EasyPrint 3D

After the installing is finished, find the icon of EasyPrint 3D. Double click it to start the software.



Step4. Select the COM Port

Click the *Printer* menu, and then select the corresponding COM Port.

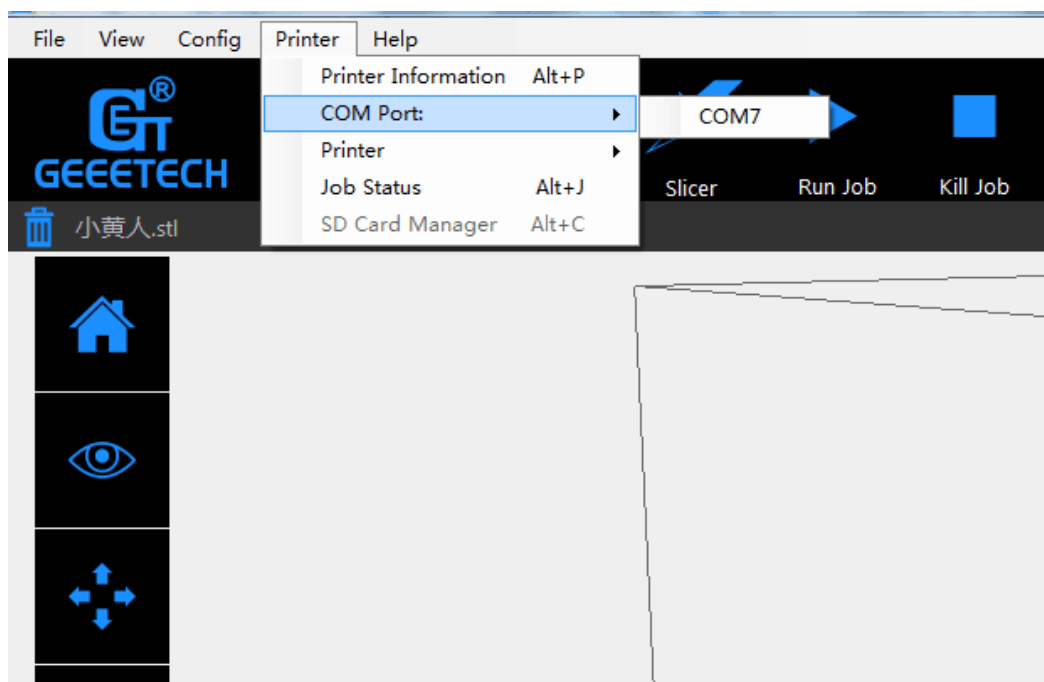

Step5. Select the Printer

Click the **Printer** menu, and then choose the printer type as D200

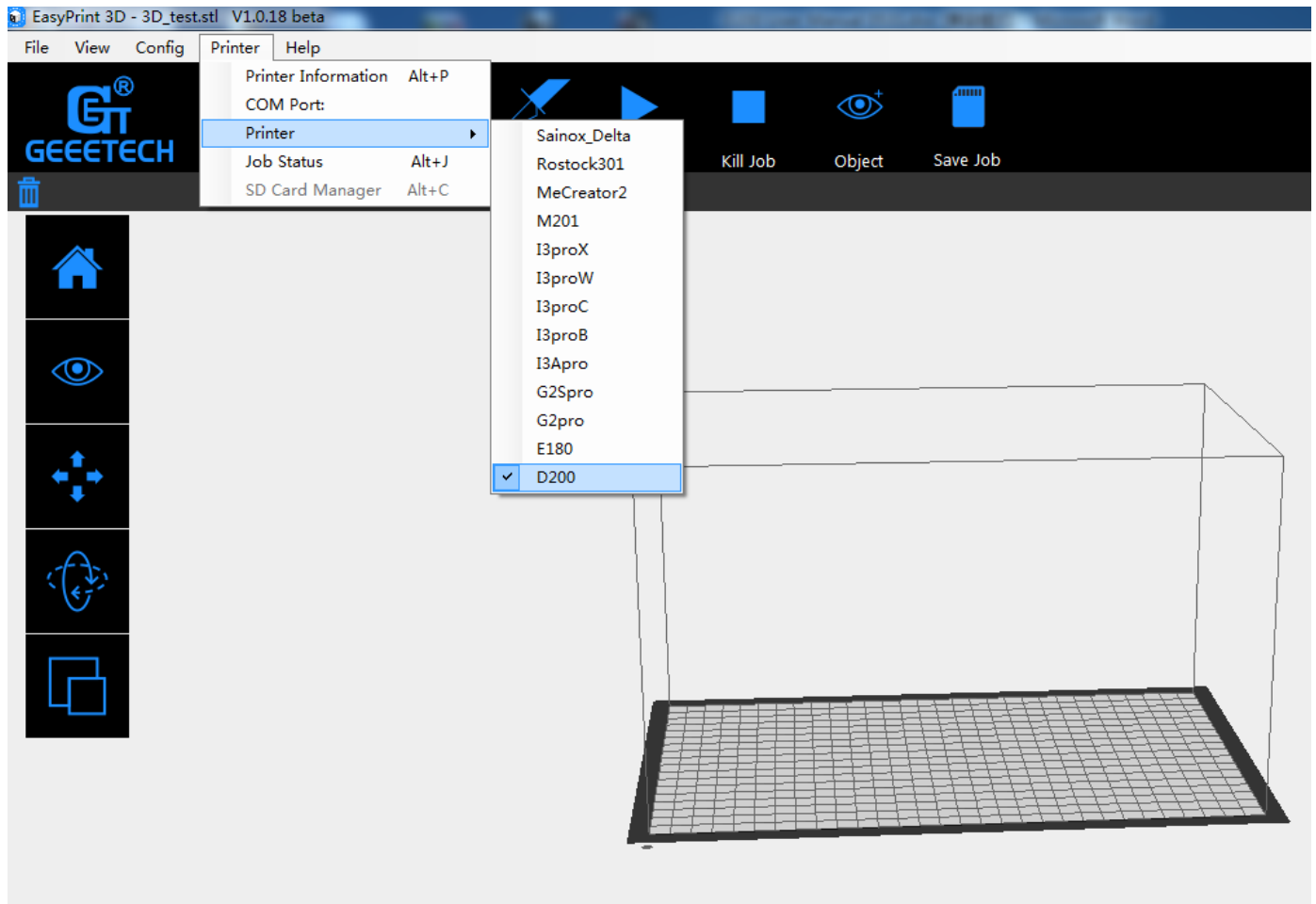

Step6. Connect

Click the **Connect** button on the top right. You could observe the real-time status of the printer on the bottom of the software interface.

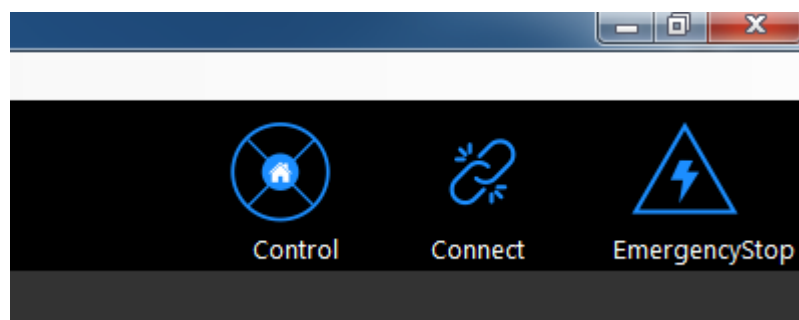

6.2.2 Load a File

Click [load] to load a.stl from your computer, or you can drag it to the 3D view window. Now you would see your model at the center of a gray rectangle, the representation of your 3D printer's build plate. Then you can use the tools on the left to edit your model.

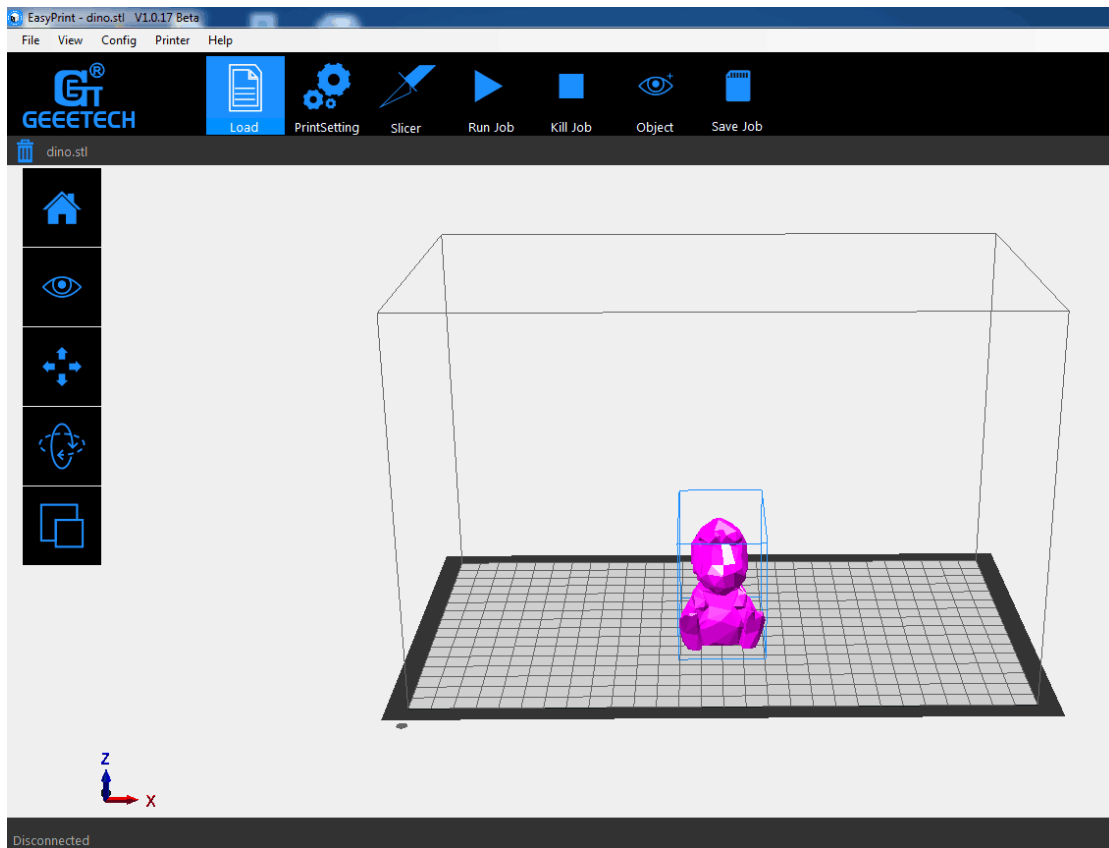

6.2.3 Printing Setting

EasyPrint 3D provides two print setting modes: [quick] mode and [custom] mode. The [quick] mode is designed for entry-level users, while the [custom] mode is tailored for expert users with fine printing parameters.

Quick mode

Choose [quick] tab. Here, we have prepared 3 printing quality settings for you.

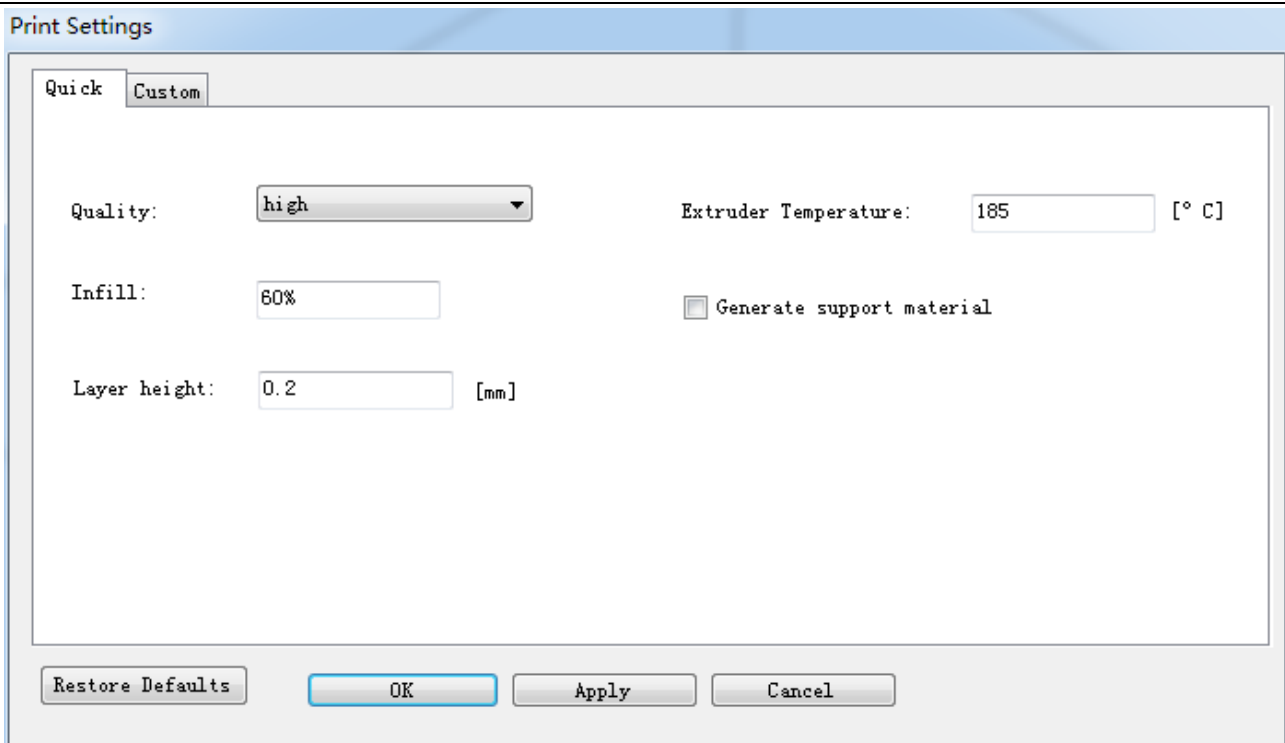

- Quality

- High: Objects sliced with the High quality profile will have finer layers and will print more slowly.
- Standard: Objects sliced with the Standard quality profile will be printed using the default settings.
- Low: Objects sliced using the Low quality profile will be printed with thicker layers and will print faster.

- Infill: The density of the infilling structure.

- Extruder temperature: Different filament requires different temperature for extruders; please refer to the suggested temperature.

- Layer height: the thickness of each layer. You can leave it as default.

- Supports

Select this checkbox to have your object printed with support structures. Easy Print 3D will automatically generate supports for any overhanging sections of your object. Supports will be easily removable once you remove your finished object from the build plate.

When you have finished the setting process, click [Apply] and [OK]. The current settings will be used to slice your model next time you print or export a print file.

Custom Mode

For advanced users who want to exert more sophisticated control over the whole printing process, Easy Print 3D provides a series of parameters for you to engineer the printing configuration.

Step 1 Create a new configuration/setting

To customize settings, you need to create a new setting first. Click the [new] tab and enter the name of new configuration in the textbox. Click [Ok].

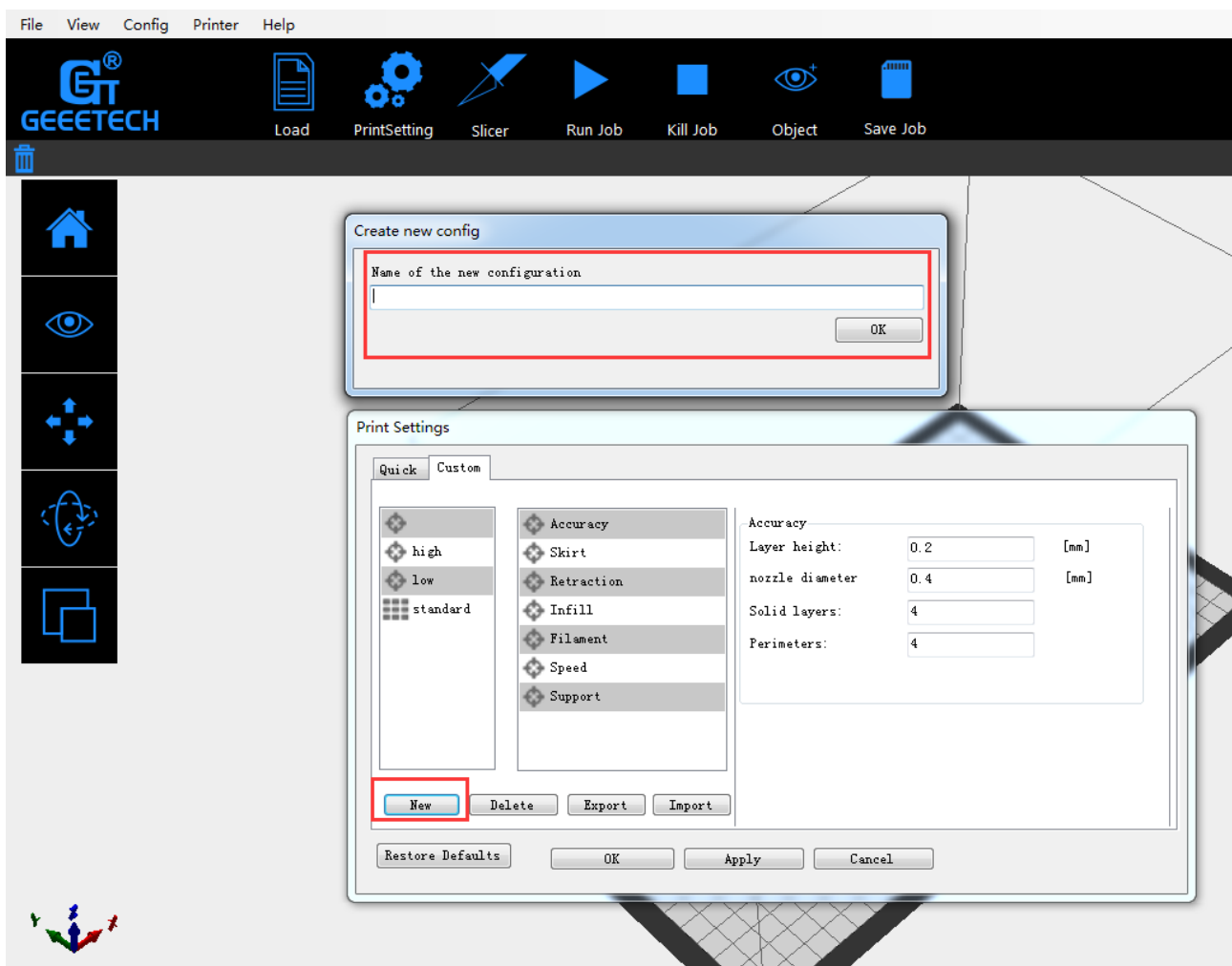

Step2. Custom settings

Choose the [custom] tab to enjoy the sophisticated print settings.

1) Accuracy:

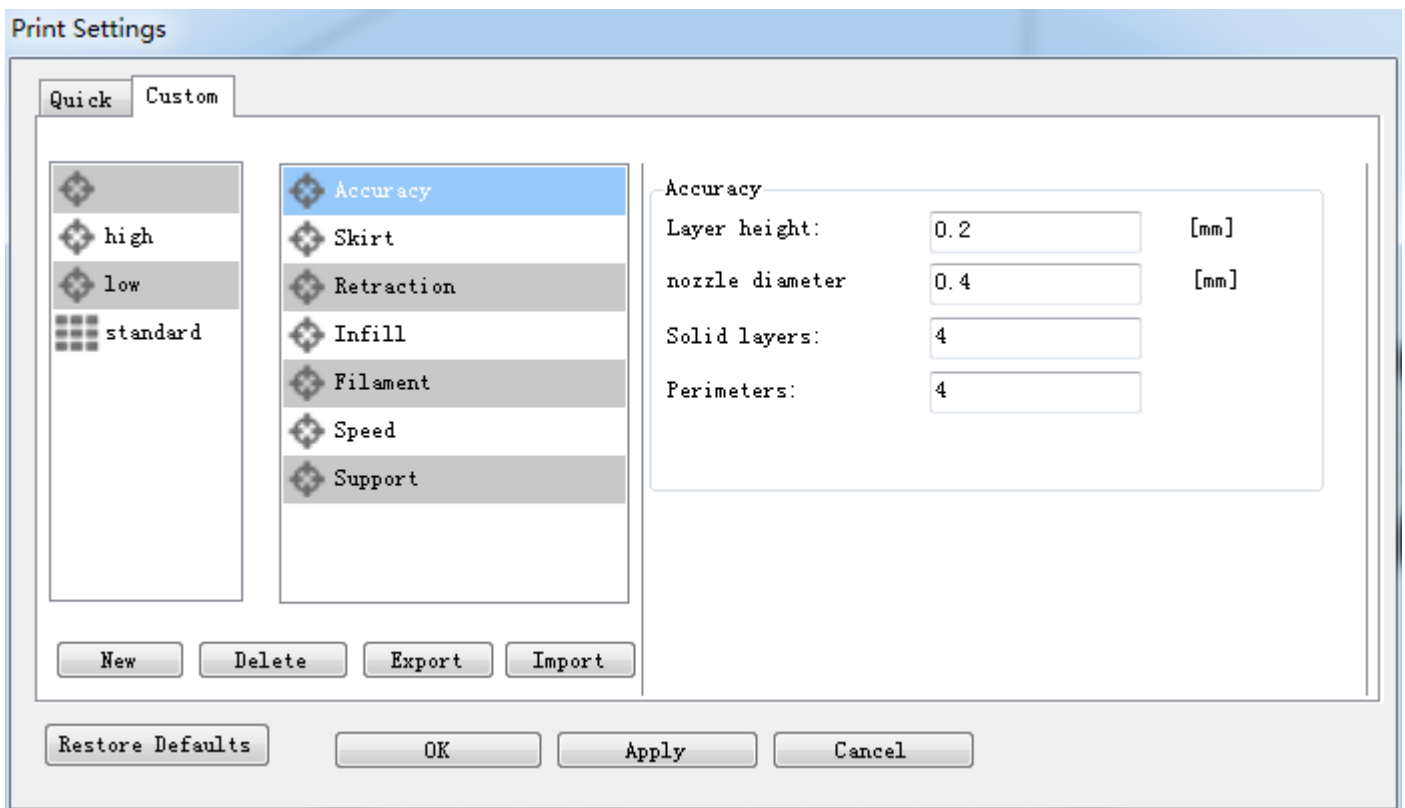

a. Layer Height:

The layer height is one of the most often adjusted settings. It is the thickness of one printed layer (in mm). With a thinner layer height you will increase the quality of the print, leading to a smoother surface and more detail visible in the Z-direction (height) of the model. On the other hand, by using thicker layers you can decrease the print time substantially.

b. Nozzle diameter: showing the diameter of the current nozzle.

c. Solid layers: The loops needed to finish just one layer.

d. Perimeter: The loops needed to finish printing one layer to make the printout more solid and the surface finish smoother.

2) Skirt:

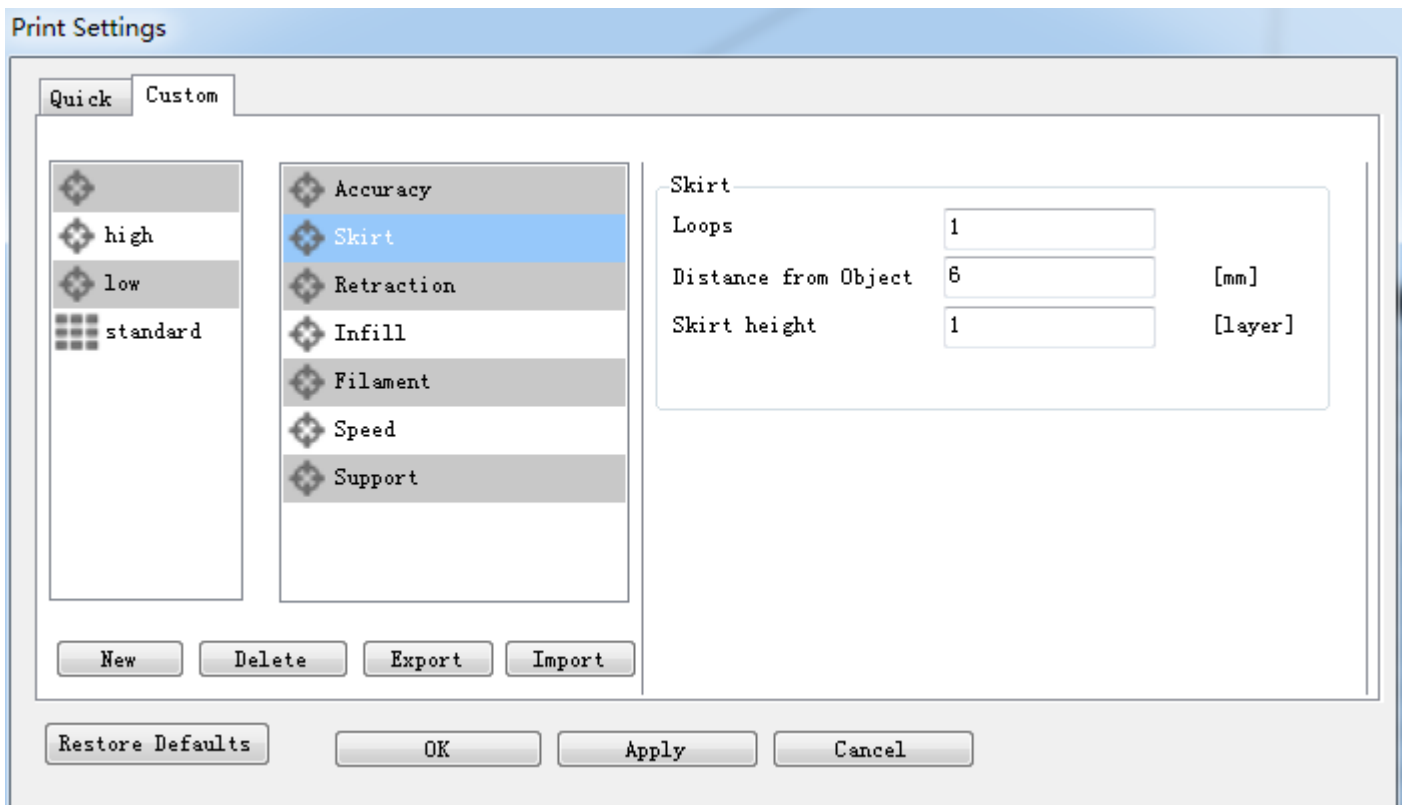

A skirt is a line printed around the object on the first layer, but not connected to the object. This helps prime the extrusion and can also be a good check for bed leveling before the print starts and it can ensure that the material is flowing smoothly from the extruder before it starts on the model proper.

a. Loops: The number of skirt lines printed around the model. One loop is usually sufficient.

b. Distance from object: The distance between the object and the skirt. The default of 6mm is usually sufficient.

c. Skirt height: The number of layers to lay down a skirt for. For ensuring the material is flowing smoothly, one layer is sufficient, however the skirt function can also be used to build walls around the object in case it should be protected from draughts.

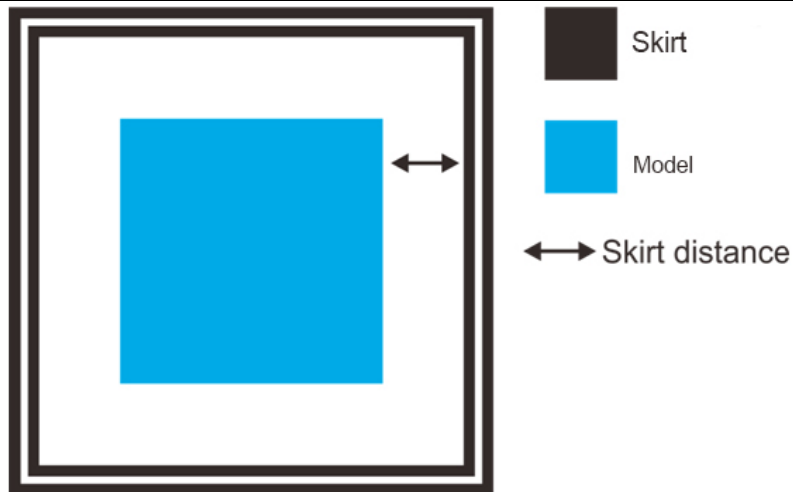

3) Retraction:

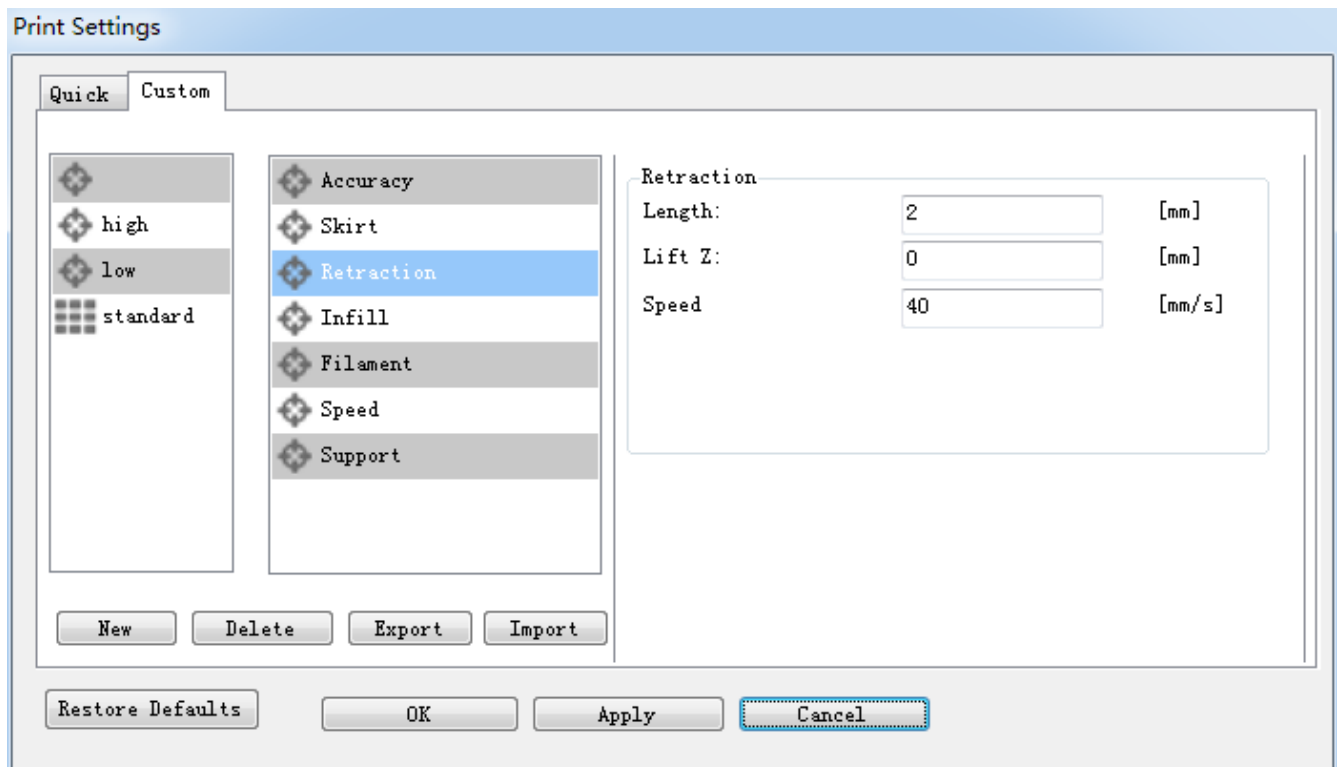

Retraction is used at the places in a print where the printer has to do a travel move between two printed parts. Without retraction, extruded material will hang between the parts. This means that the filament is pulled back by the feeder, so that it doesn't leak from the nozzle during the travel moves. By using retraction, "stringing" (thin threads of plastic in between the printed parts) is prevented, resulting in a cleaner final model. You have to be careful with flexible materials or models that require a lot of retractions, as that might lead to grinding of the filament.

a. Length: The number of millimeters to retract. Note that the measurement is taken from the raw filament entering the extruder. A value of between 1 and 2mm is usually recommended. Bowden extruders may need up to 4 or 5mm due to the hysteresis introduced by the tube.

b. Lift Z: Raises the entire extruder on the Z axis by that many millimeters during each travel. This can be useful to ensure the nozzle will not catch on any already laid filament; however it is usually not necessary and will slow the print speed. A value of 0.1mm is usually sufficient.

c. Speed: The speed at which the extruder motor will pull back the filament. The value should be set to as quick as the extruder can handle without skipping steps, and it is worth experimenting with this value to find the quickest retraction possible.

4) Infill:

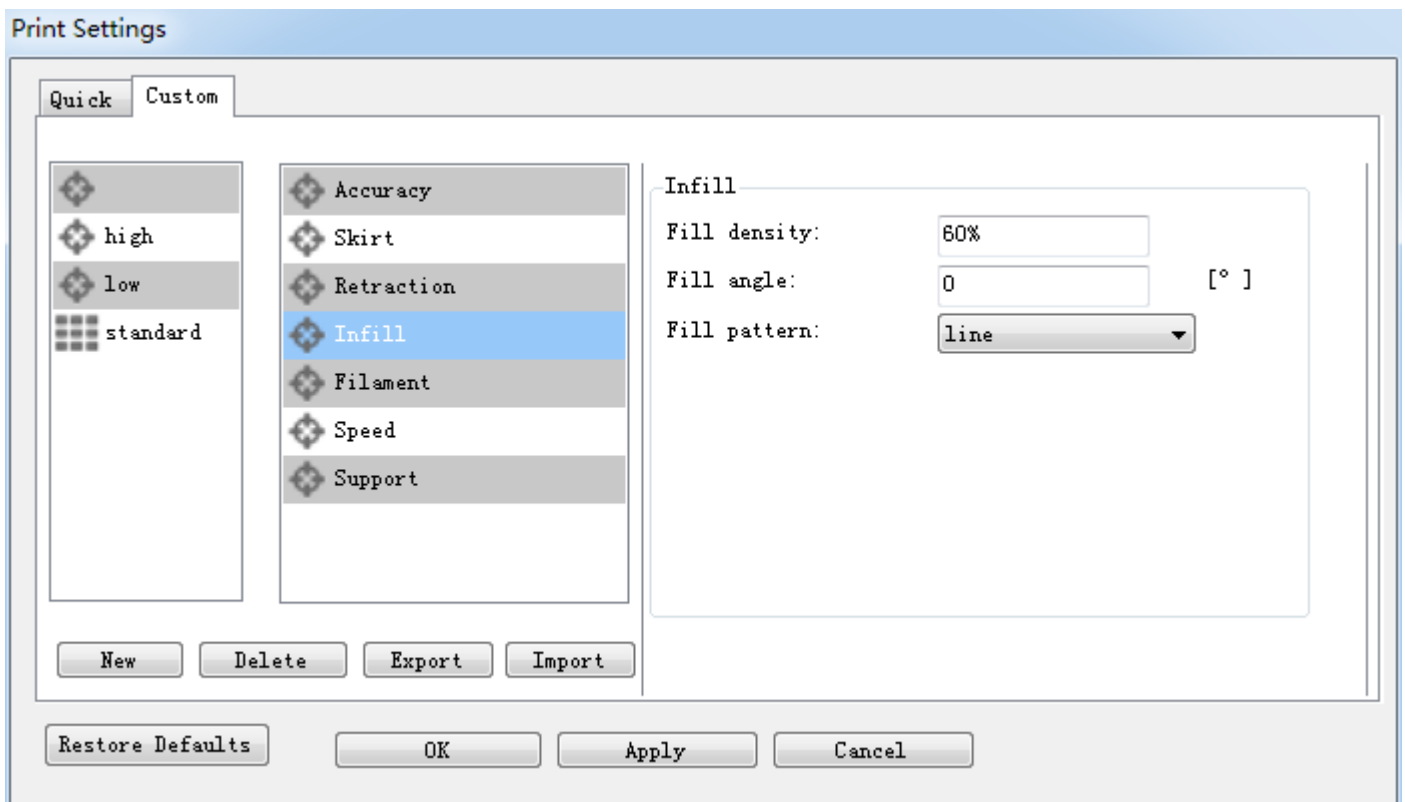

a. Fill Density: The infill density defines the amount of plastic used inside the print. A higher infill density means that there is more plastic on the inside of your print, delivering a stronger object. An infill density around 20% is used for models with a visual purpose; higher densities can be used for end-use parts.

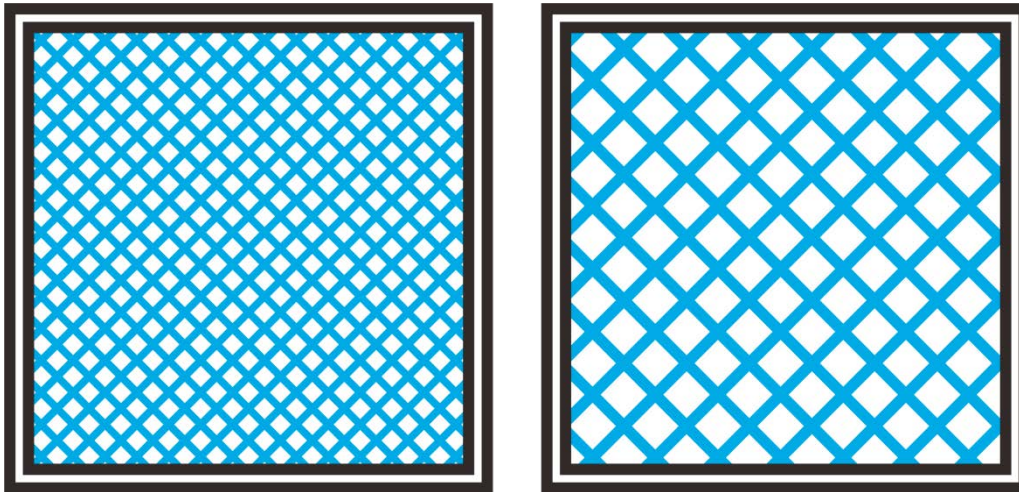

c. Fill angle: By default the infill pattern runs at 45° to the model to provide the best adhesion to wall structures. Infill extrusions that run adjacent to perimeters are liable to delaminate under stress. Some models may benefit from rotating the fill angle to ensure the optimal direction of the extrusion.

d. Fill Pattern: It is the pattern of filling shape which effects printing duration.

Easy Print 3D offers seven infill patterns, including four regular flavors, and three more exotic ones. The numbers on the right of each figure are a rough estimate of material used and time taken for a simple 20mm cube model. Note that this is only indicative, as model complexity and other factors will affect time and material.

1. Line :

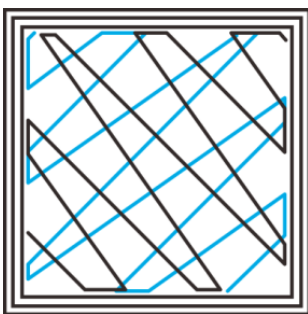

350.57mm/5m: 23s

2. Rectilinear

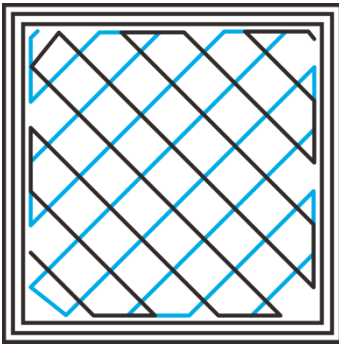

344.51mm/5mins 20s

2. Rectilinear

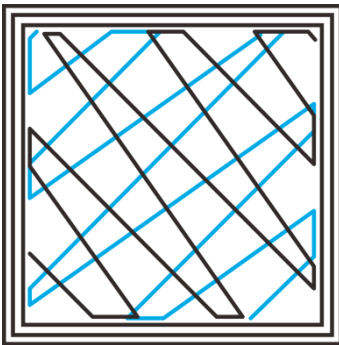

344.51mm/5m: 20s

3. Concentric

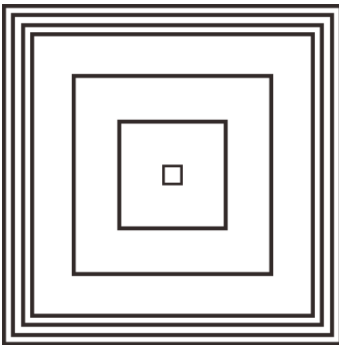

344.51mm/5m: 20s

4. Hilbert Curve

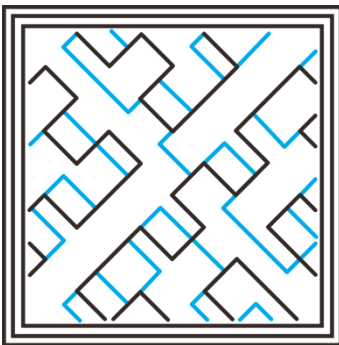

332.82mm /5m: 28s

5. Archimedean Chords

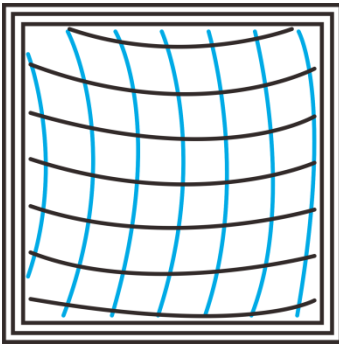

333.66mm /5m: 27 s

6. Octagram Spiral

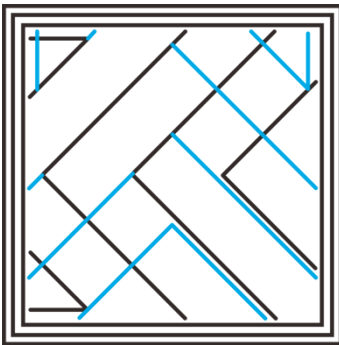

318.63mm/5m: 15 s

7. Honeycomb

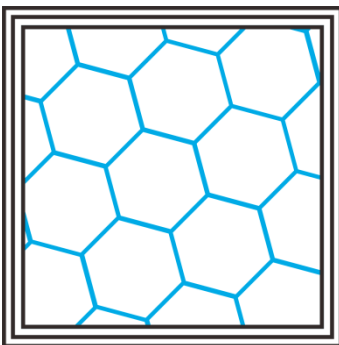

362.73mm /5m: 39s

5) Filament:

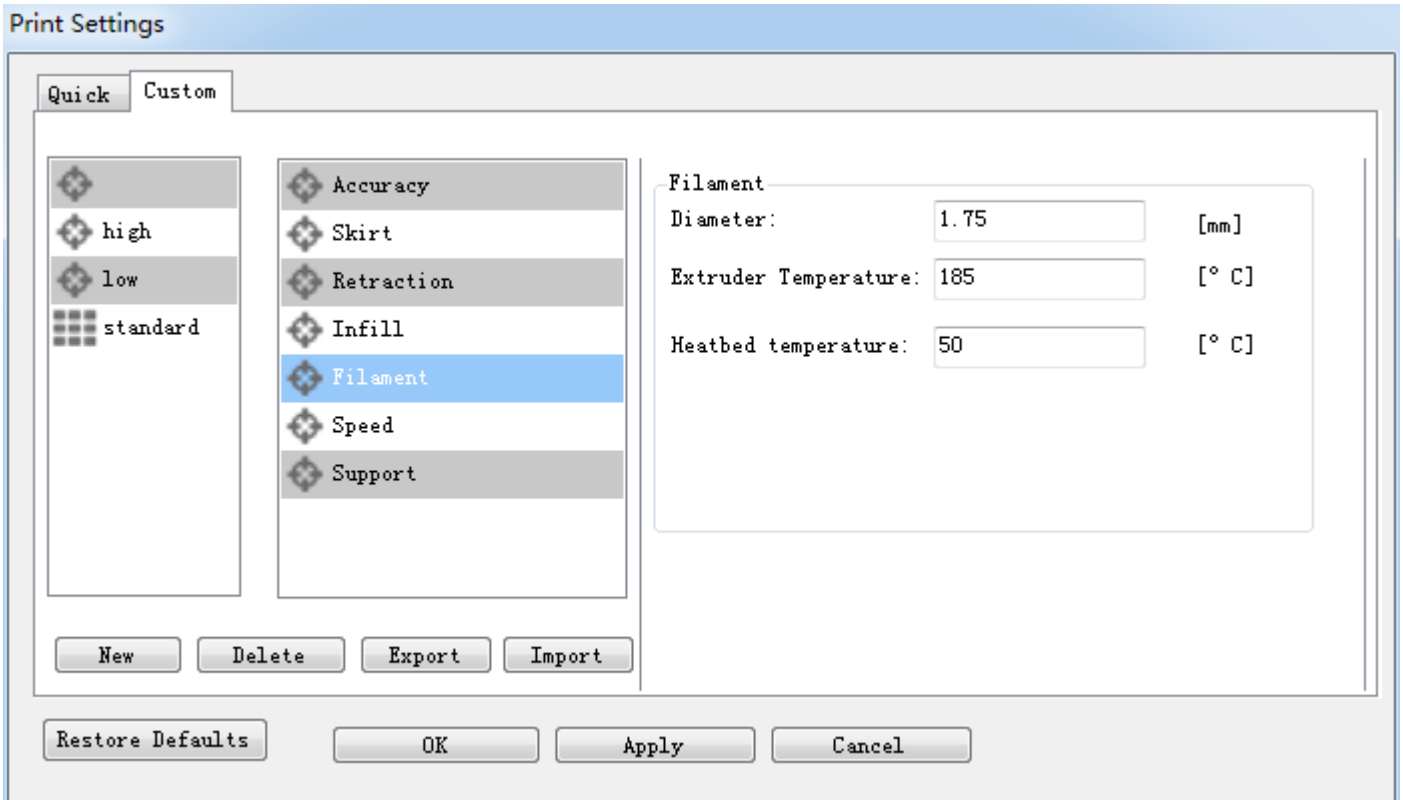

a. Diameter:

In this field you can enter the diameter of the filament, so that Easy Print 3D could calculate the extrusion rate correctly. The most commonly used filament diameters are 1.75mm and 3mm, but it might be necessary to change this setting when using filament from other suppliers.

b. Extrusion temperature:

This is the temperature of the nozzle during printing. The extrusion temperature can differ with different materials. PLA, for example, needs a printing temperature of approximately 180-210 °C, while ABS needs a higher temperature of 210 - 230 °C to properly extrude the material.

c. Heatbed temperature

For printers with a heated bed, the temperature of the heated bed can also be set here. We recommend 60 °C for PLA and 90 -110°C for ABS to ensure that the filament sticks well to the build plate. About the temperature requests of other filament to the hotbed, please make reference to the proposal from the filament manufacturer.

6) Speed:

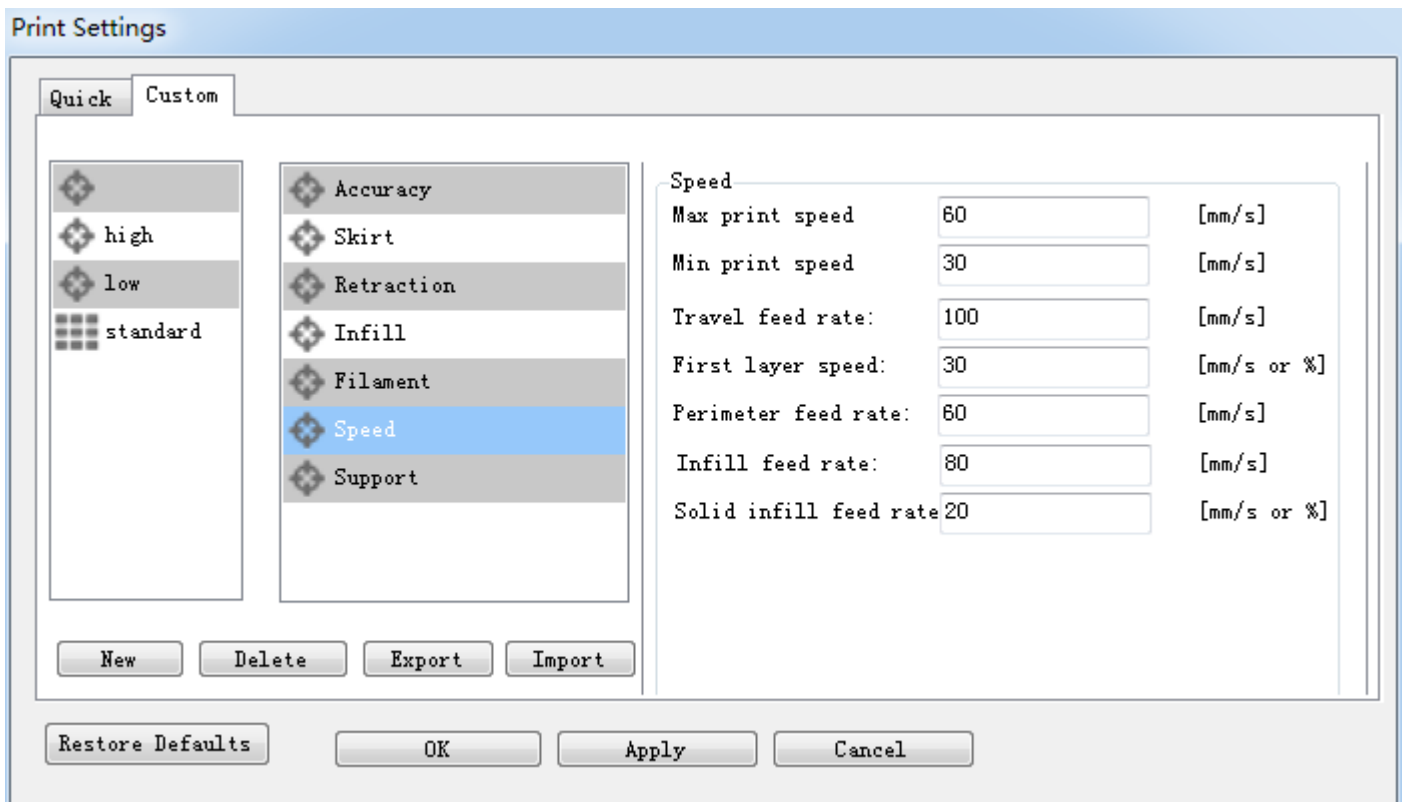

The print speed defines at which speed (in mm/s) the print head moves while printing. Based on this setting, Easy Print will also calculate how fast the filament must be extruded. A higher print speed will lead to a shorter print time. But keep in mind that increasing the print speed means that you might have to increase the temperature as well, to ensure the plastic is properly melted.

Although you can choose one overall print speed for the complete print, it's also possible to use different print speeds for specific parts of the print:

- a. Max/Min print speed: Different printer supports the different speed. Generally speaking, this parameter is the default.
- b. Travel feed rate: This is the speed at which the print head moves when it's not extruding, that is, when the print head is moving from one point to another. A higher travel speed decreases the chance of filament leaking from the nozzle, producing a cleaner object. On the other hand, a very high speed means that the nozzle can hit an already printed part so fast that it might be damaged or deformed by the hot nozzle. This can be prevented by using lift z when retracting though.

c. First layer speed: With this setting you can specifically change the speed for the first layer of the print. By default a low speed is used for the bottom layer, so that the material sticks well to the build plate on the first layer. As mentioned in the above section, the first layer is important to lie down correctly, and a slower pace helps enormously. Setting a value of 50%, or even less can really help.

d. Perimeter feed rate: The speed at which the walls are printed. You can also set the speed for the outer and inner wall separately. Printing the outer wall a bit slower usually results in a better surface finish.

e. Infill feed rate: The speed at which the infill material is printed. Since (visual) quality of the infill is not important, you could use a higher speed for the infill. But keep in mind that this might affect the strength of your print.

f. Solid infill speed: The speed at which the top layers are printed. A lower speed increases the reliability of closure of the top layers, especially on large area prints.

7) Support:

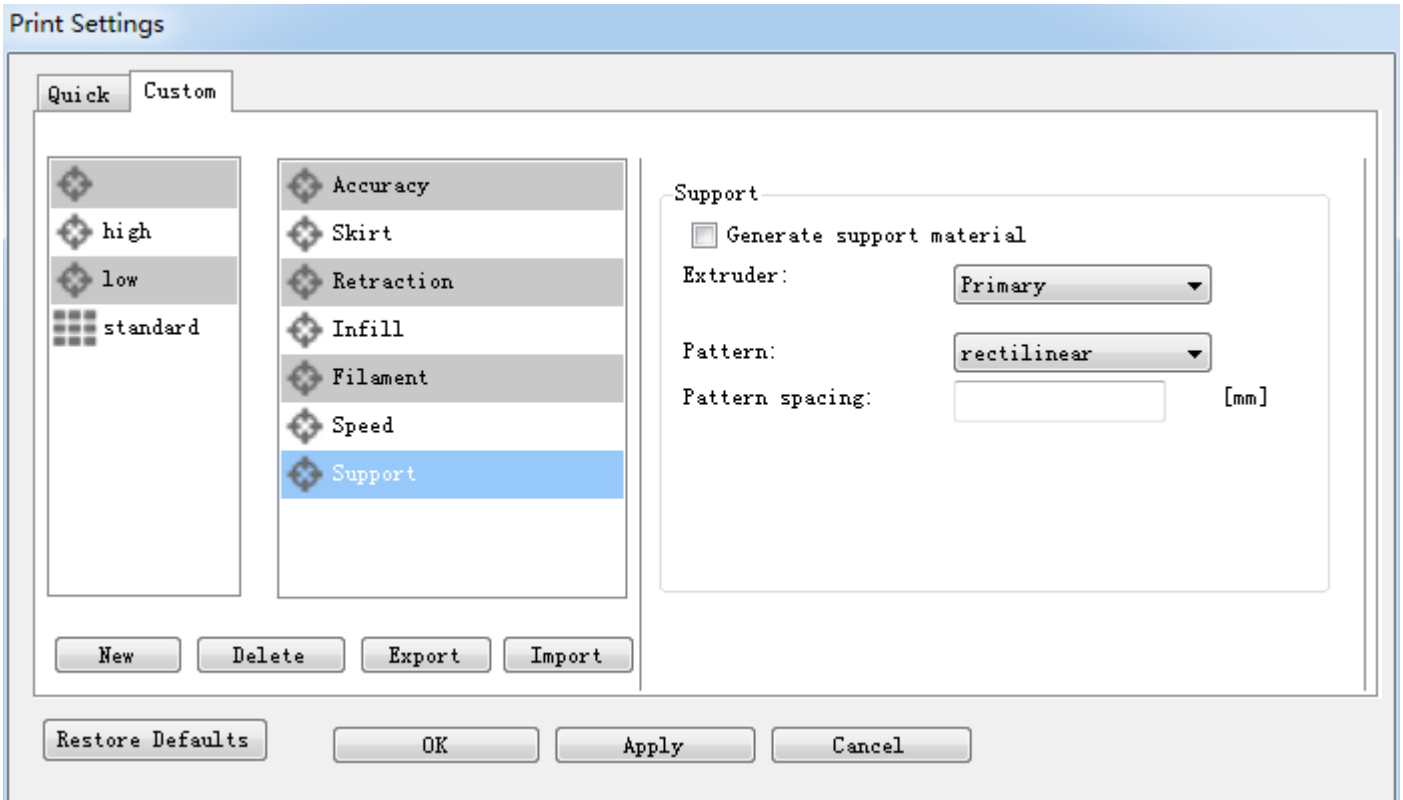

Generally, most 3D models will print with overhanging parts by up to a certain degree. The angle is determined by several factors, most notably layer height and extrusion width, and is usually around 45°. For models with larger overhangs, a support structure may have to be printed below. This incurs the use of more material, longer print time, and post-printing clean-up.

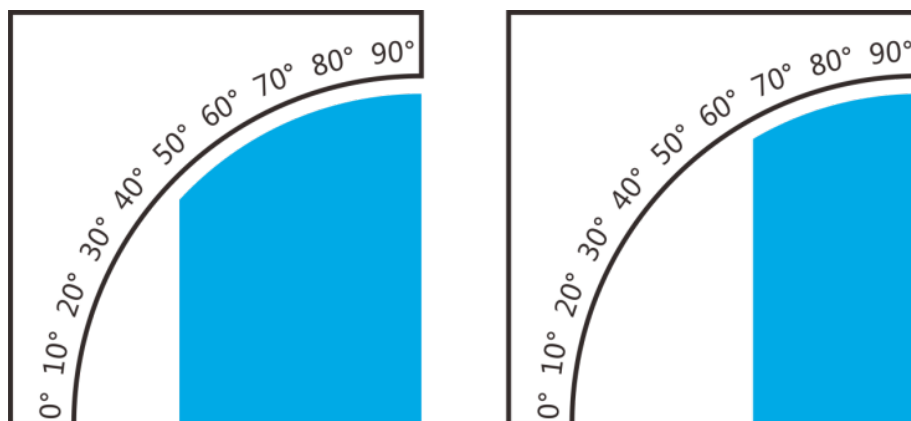

Support (the blue part)

a. Generate support material

Some models have overhanging parts, which means that parts of the model float mid-air when you would print the model. In this case you must use a support structure under the model to prevent the plastic from falling down. This can be achieved by generating support material. Select this checkbox to have your object printed with support structures.

b. Extruder

If you are printing with dual extruder, you can select one of them to print the support material.

c. Pattern

There are two different patterns available for printing support structures, resulting in sturdiness or the easiness to remove the support. You can choose from the following patterns.

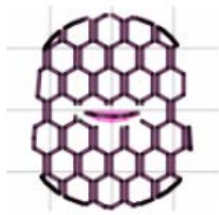

(1) Honeycomb



(2) Rectilinear

d. Pattern Spacing

Pattern Spacing determines the distance between support lines, and is akin to infill density apart from being defined only in mm. The adjustment of this attribute by taking into account the width of the support extrusion and the amount of support material will adhere to the object.

Care should be taken to choose a support pattern which matches the model, where the support material attaches perpendicularly to the wall of the object, rather than in parallel, so it will be easy to remove. If the support structure does run along the length of a wall, the Pattern Angle option allows the direction of the support lines to be rotated.

Now all the parameters are set. Click [Apply] and [OK] to save it.

6.2.4 Slicing

After loading the model file and adjusting printing parameters, you can click the [slicer] icon to slice. It will take a while. The slicing time depends on the size of the model.

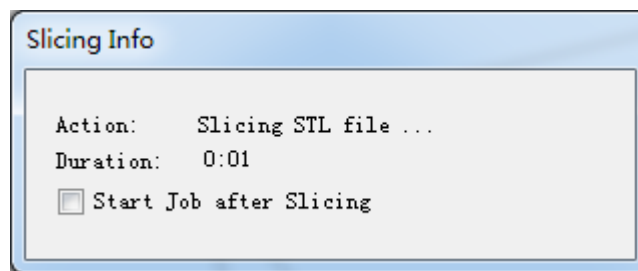

Upon slicing, you get the sliced .gcod file.

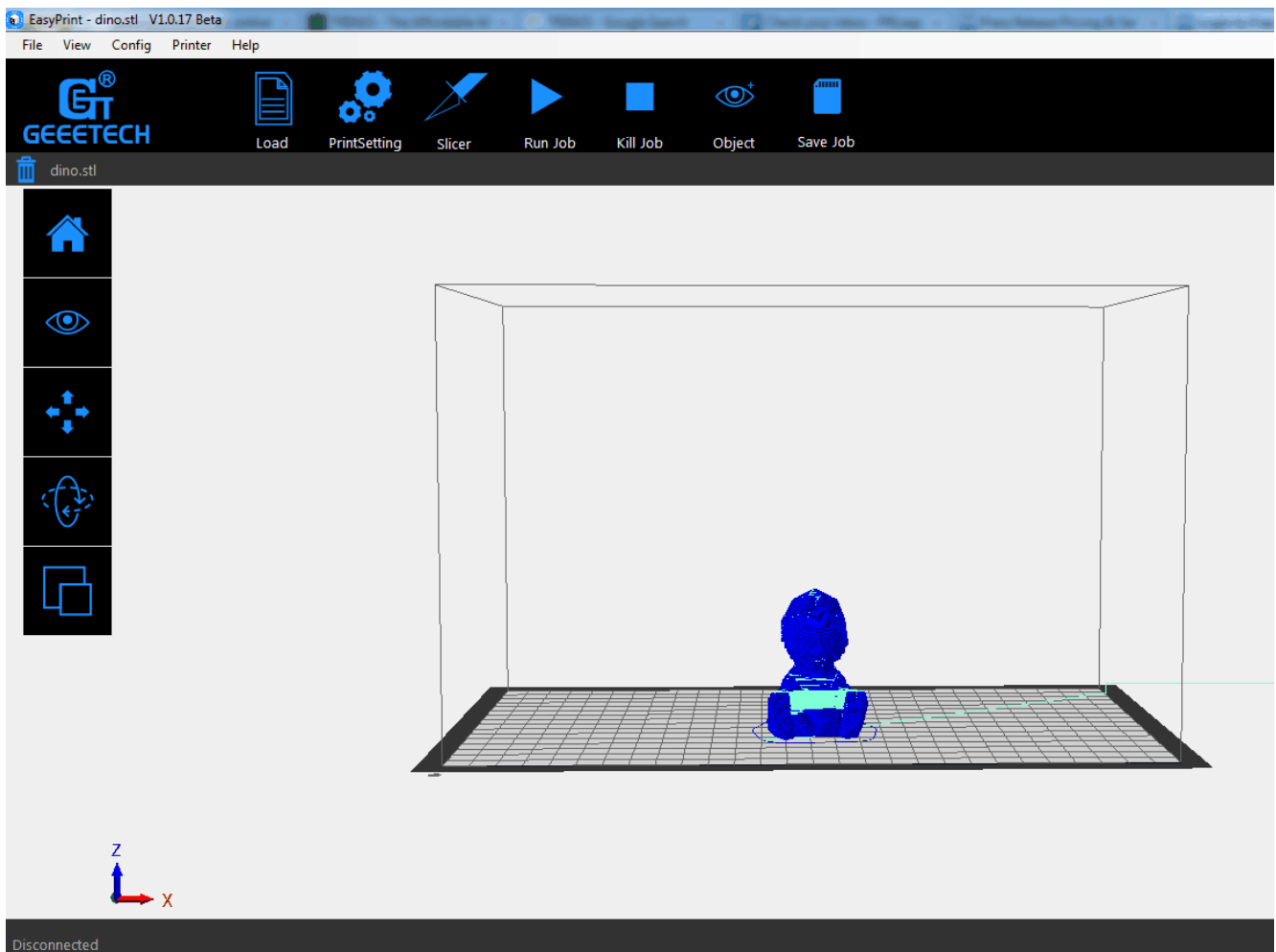

When you are ready to print your model, click [Run job] to embark on your printing journey

6.2.5 Save slicing

If you want to use SD card to print, we can save g.code file into SD card for printing.

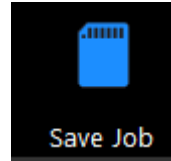

Click [Save job] for SD printing and select the [save] button in the dialog box. Then g.code file can be directly saved in SD card.

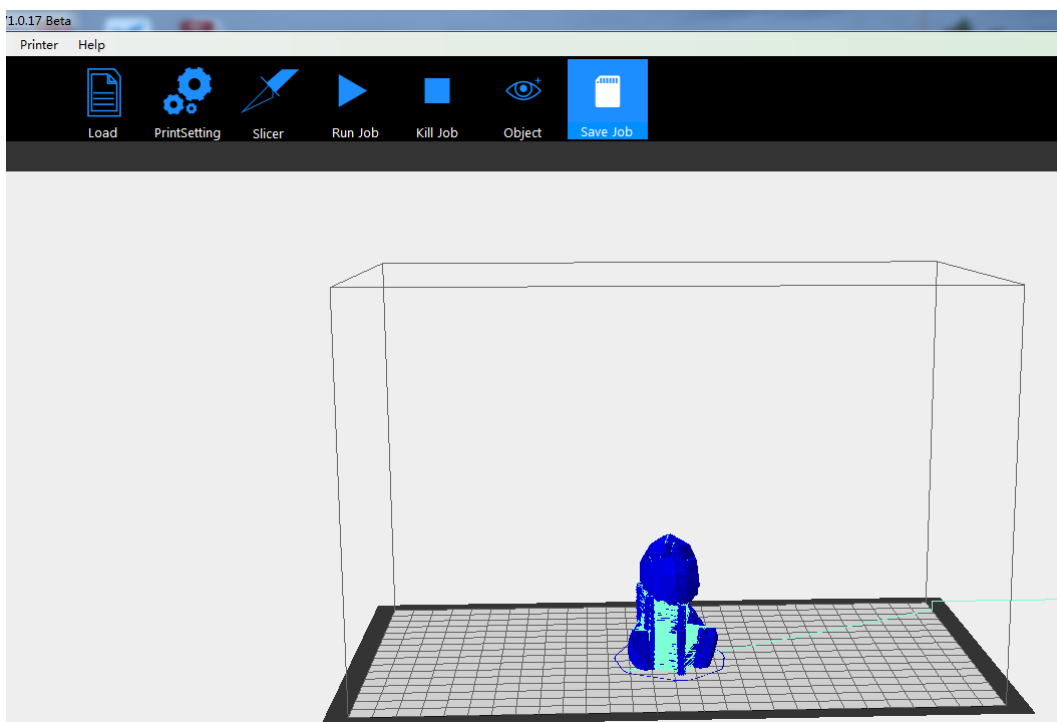

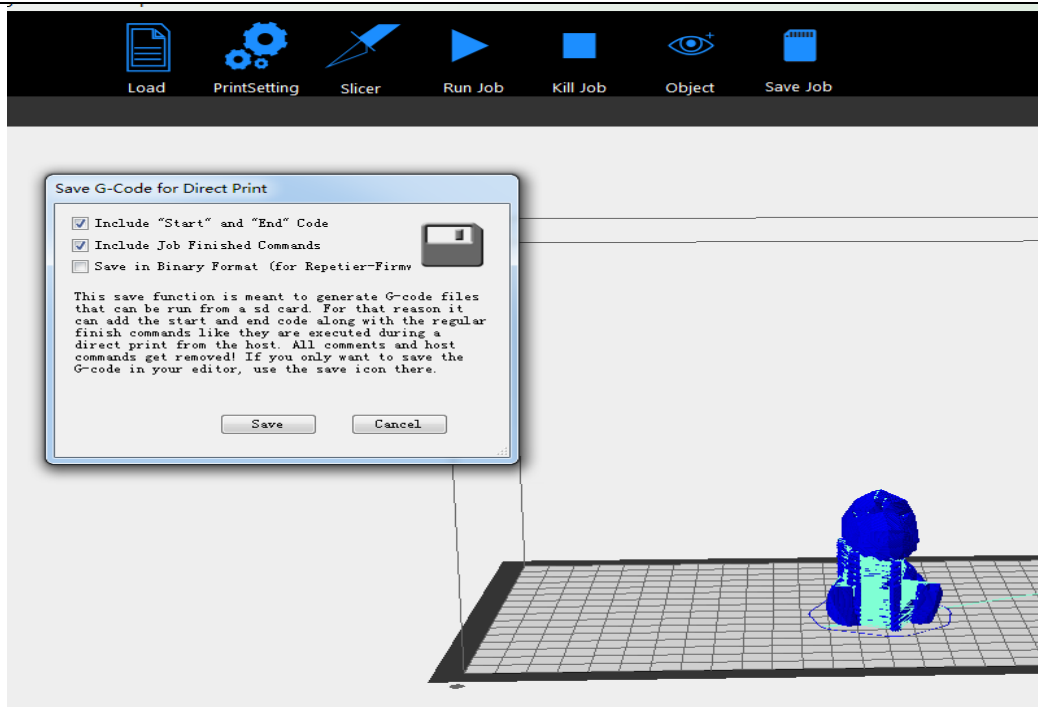

Note: The file should be saved in the root directory of the SD card.

6.3 Print via Wi-Fi

GIANTARM D200 Cloud 3D printing solution conveniently provides users EasyPrint 3D App to enjoy free and giant 3D models, just slightly press to start your printing journey. Even if you are not keeping company with your printer, you can control the printer via EasyPrint 3D APP.

EasyPrint 3D App offers the simple, intuitive user interface, full-featured and easy-to-manage. Paired with built-in Wi-Fi of the printer, you can select the 3D model from cloud library via APP, adjust the printing setting in real time, monitor the printing process and save the relevant files.

EasyPrint 3D App only supports Android system so far. IOS system is under developing. Please stay tuned.

6.3.1. Install EasyPrint 3D APP

Download the EasyPrint 3D APP here and install the EasyPrint 3D APP.

www.geeetech.com/firmware/EasyPrint3D_Android.apk

Once finishing installation, enter *My Center* to register and log in.

You can download the App via [Apple Store](#) or [Google Play](#).

6.3.2. Bind printer to EasyPrint 3D APP

Log in and bind the printer. In *My Center—My 3D Printer*, finish the binding process following the instructions on APP.

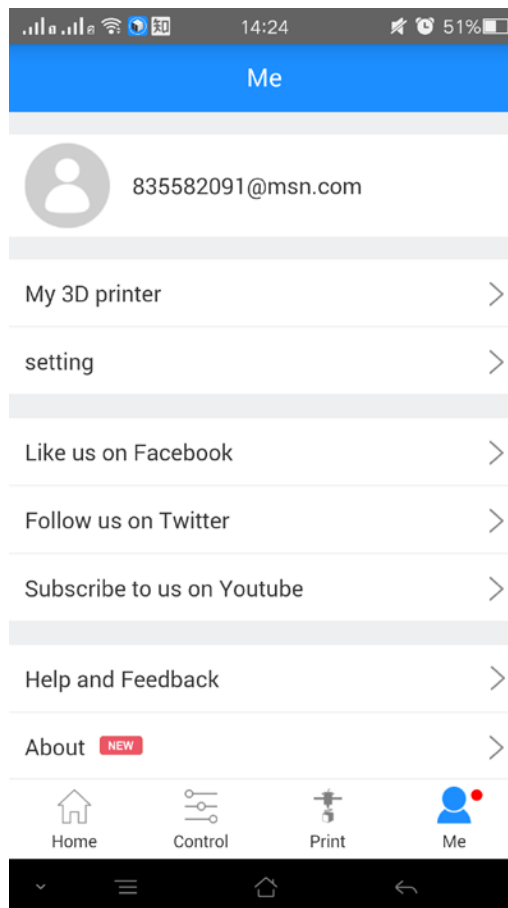

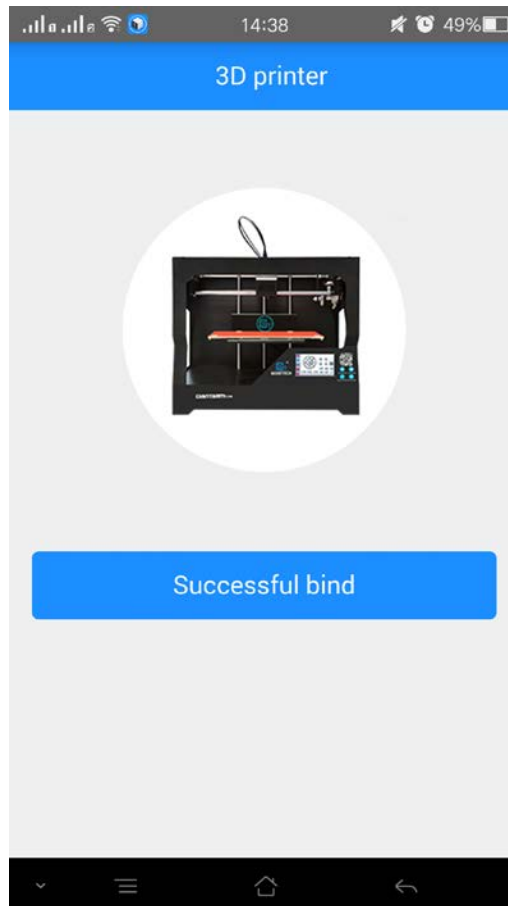
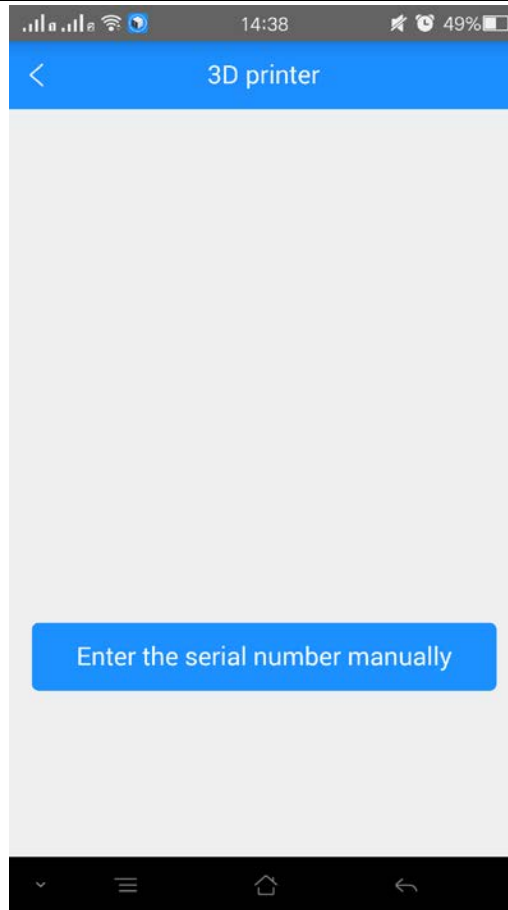

Detailed configuration procedures are as following:

Note: Please make sure that the Wi-Fi frequency of your router is at 2.4G.

①. In Wi-Fi setting interface on the control panel, choose Wi-Fi button  to enter Wi-Fi interface, as shown in the picture below.

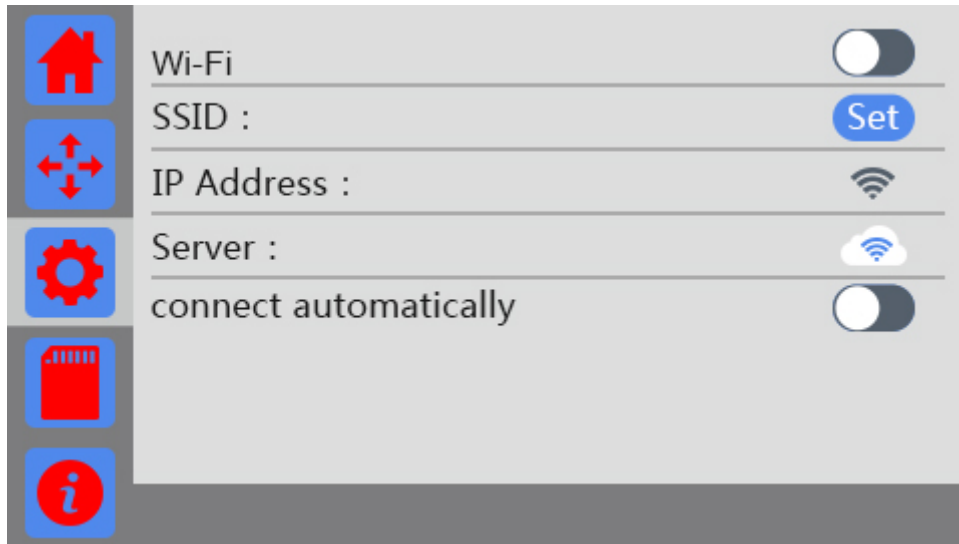

②. Turn on Wi-Fi and click the button “Set “to enter the Config mode, as shown in the picture below.

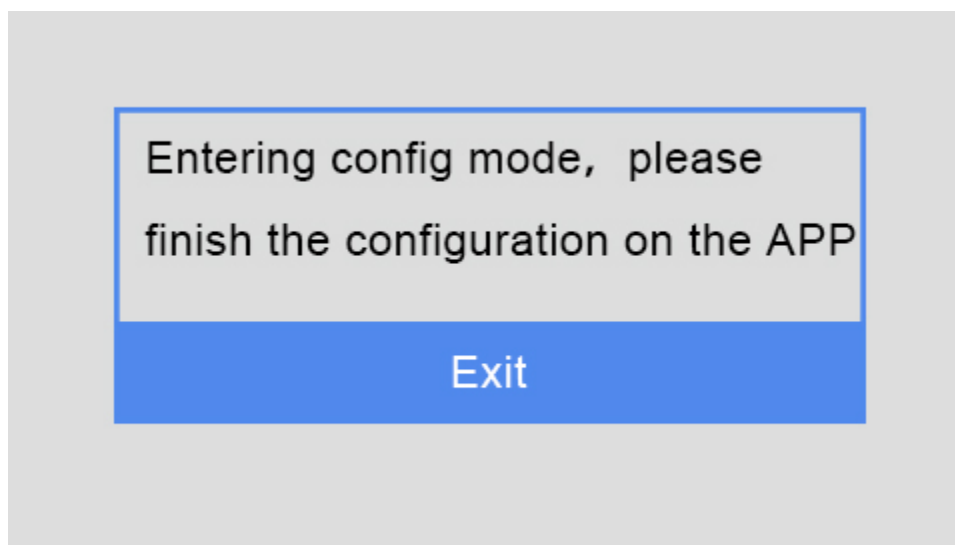

③. Choose Wi-Fi at the control panel on APP. At the page of pop-up, click the button “Wi-Fi” to enter Wi-Fi configuration, as shown in the picture below.

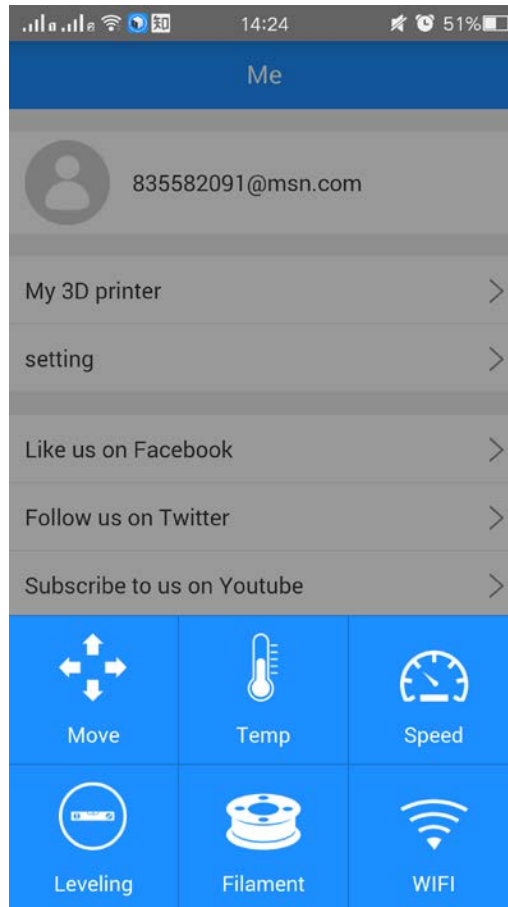

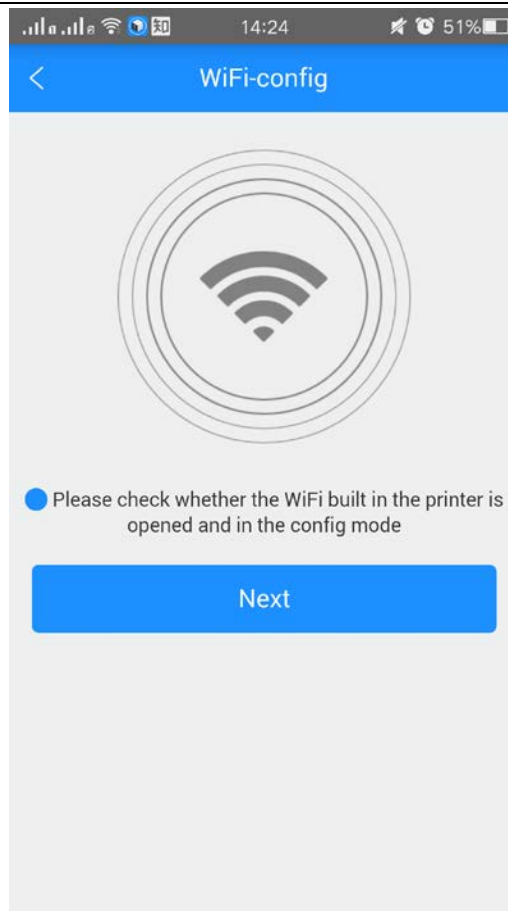

④. Click [Next] to start to detect Wi-Fi built in the printer. If not detected, it will pop up a prompt “Printer Wi-Fi is not detected” . Click [OK] and again click [Next] to redetect. If the Wi-Fi is detected, you could see the following picture.

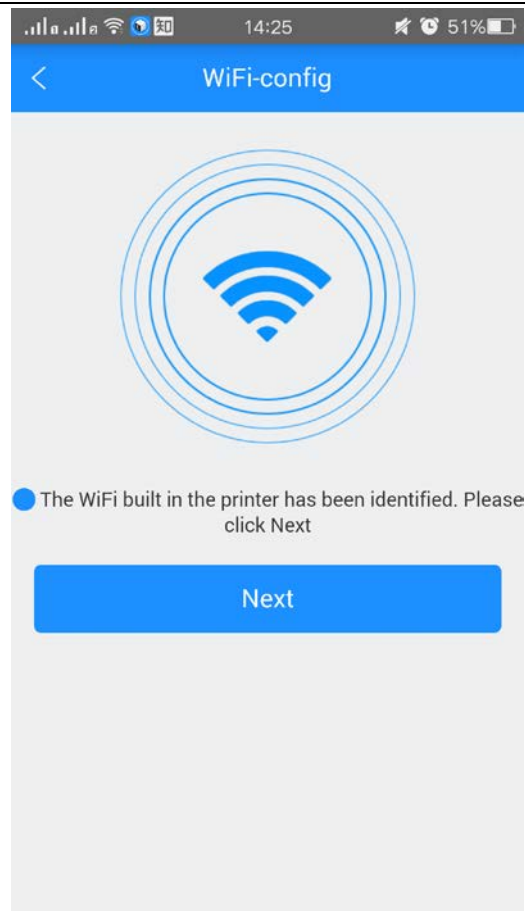

⑤ Click [Next] after Wi-Fi hotspot is detected, as shown in the picture below.

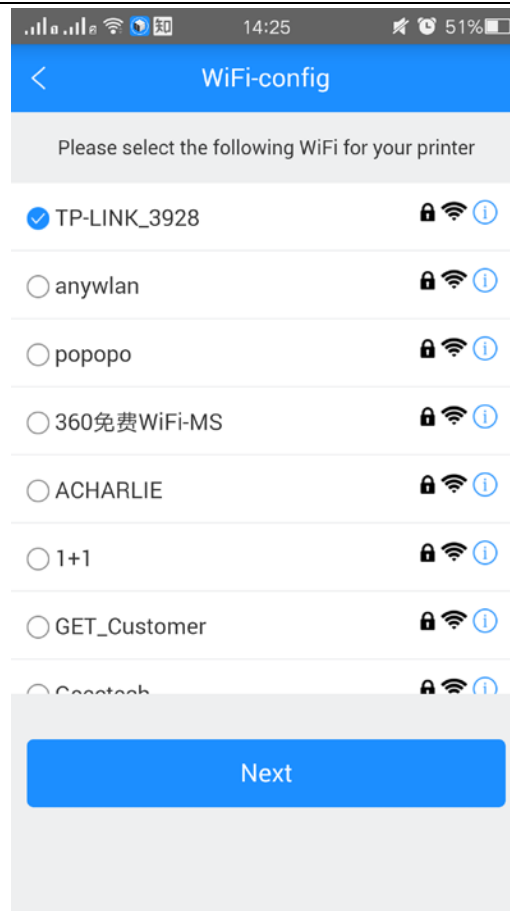

⑥ Choose one of the available Wi-Fi hotspots. Click [Next], and, if the Wi-Fi needs the password, the interface will show the Wi-Fi password input box. Just input the correct password, and then click “[OK]”, as shown in the picture below.

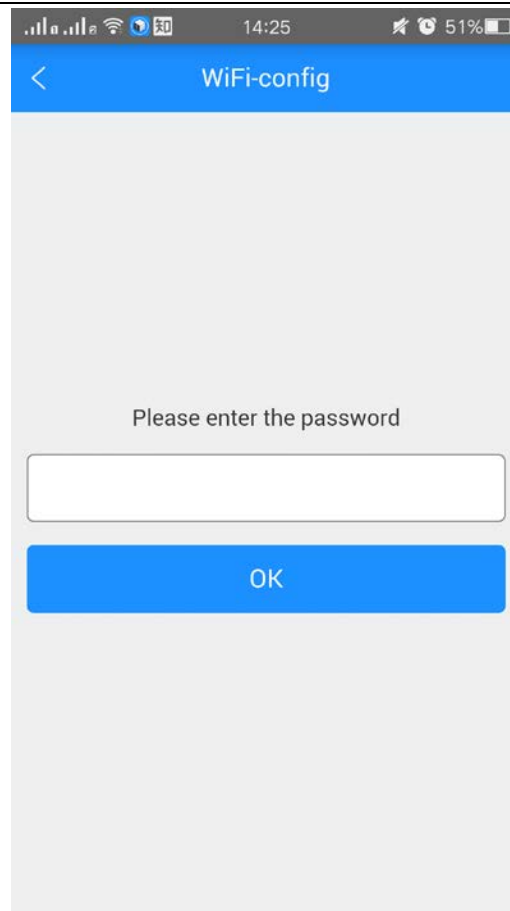

⑦. When you succeed in connecting the Wi-Fi, the interface will show that the configuration is finished, as shown in the picture below.

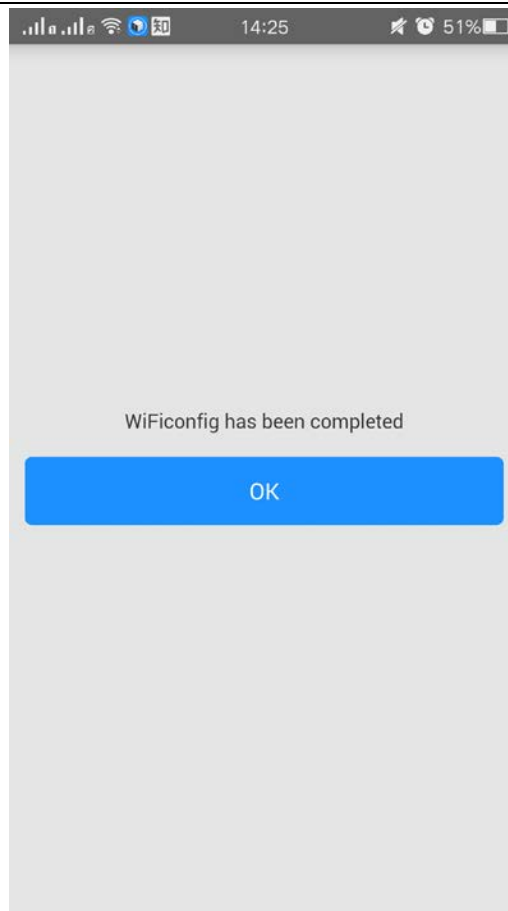

Then the interface returns back to the control panel of the printer. You can see the prompt, as shown in the picture below.

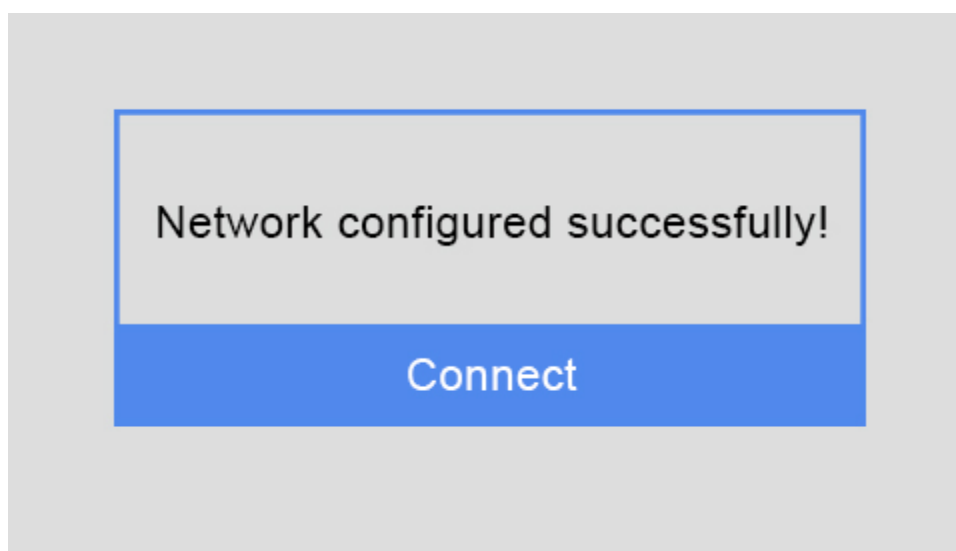

Click the button “Connect” on control panel, the interface will skip to Wi-Fi interface to connect with Network. The icon and status bar of Wi-Fi become blue on Wi-Fi interface. Meanwhile, SSID, IP Address and Server on this interface will display the relevant information, as shown in the picture below.



Go back to APP, click “[OK]” to enter the home page. The status on the homepage displays that the printer is on-line. Till here, the configuration between APP and the printer is finished. Now you can print and control the printing via APP.

⑧. If you choose a Wi-Fi hotspot without password, click “Next” and continue your setting from step ⑦.

6.3.3 Printing from cloud library

As above, once the configuration between APP and the printer is successful, you can start to print.

Note: A SD card is still needed when print via Wi-Fi to save the files.

Step 1. Click **Print** — **Cloud library**, choose the type of models

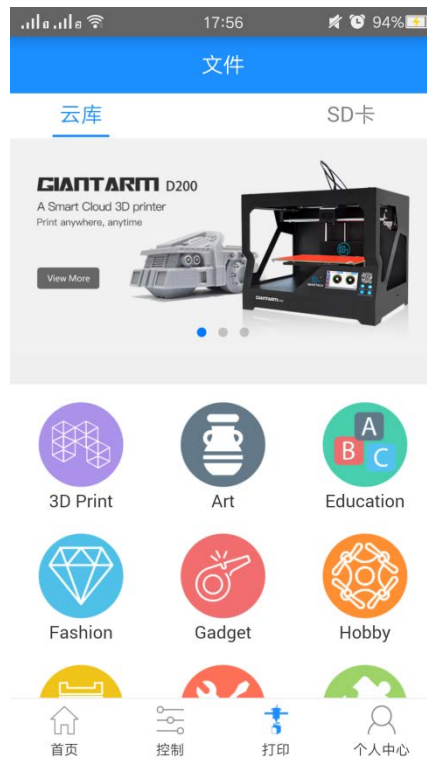

Enter the model page; choose your favorite model, let's take the "Rose" as an example:

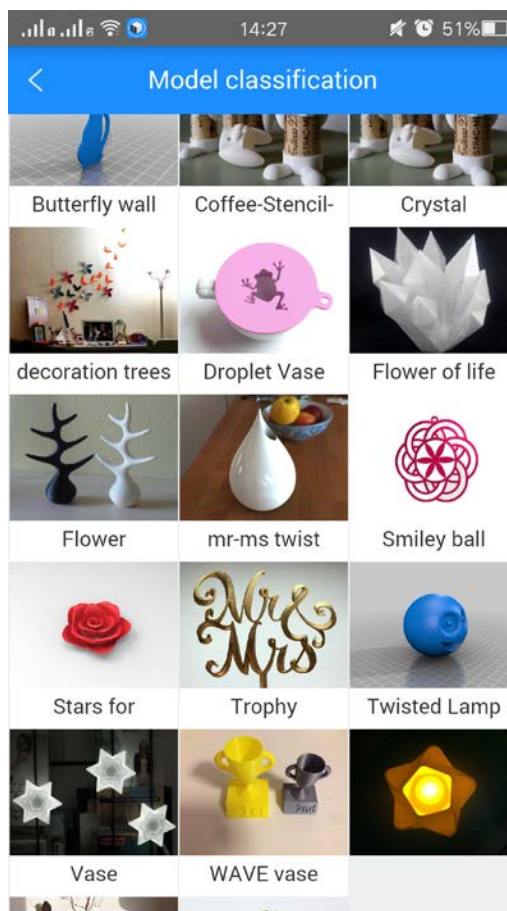

Enter the [Model details] page, click the button "Print" here, you can preview to the model

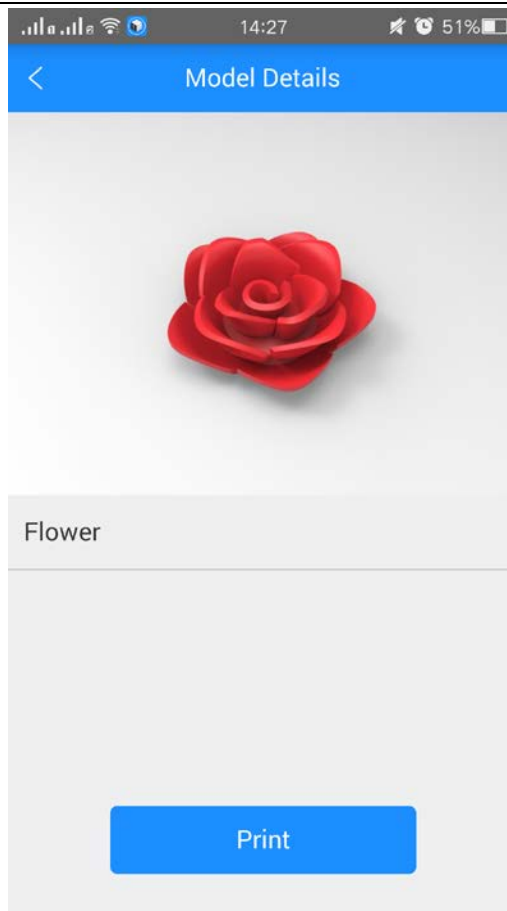

You can make some simple operations to the model on the screen with fingers, such as, zooming, rotating or moving.



Click the “Print” button to start print. This will take a while to transfer the file from the cloud server to your printer. Please keep your wireless networks unimpeded.

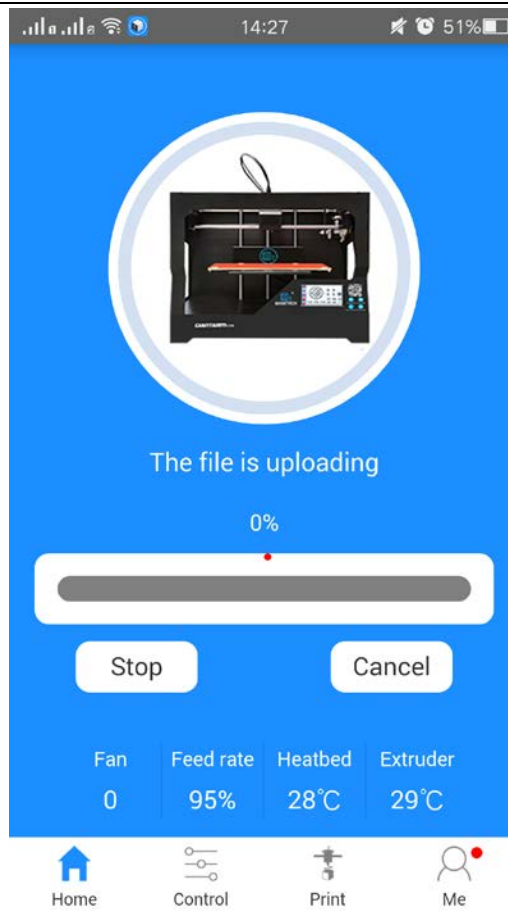

During the uploading, you can pause the uploading or give it up.

Upon uploading, it will start printing after a while.

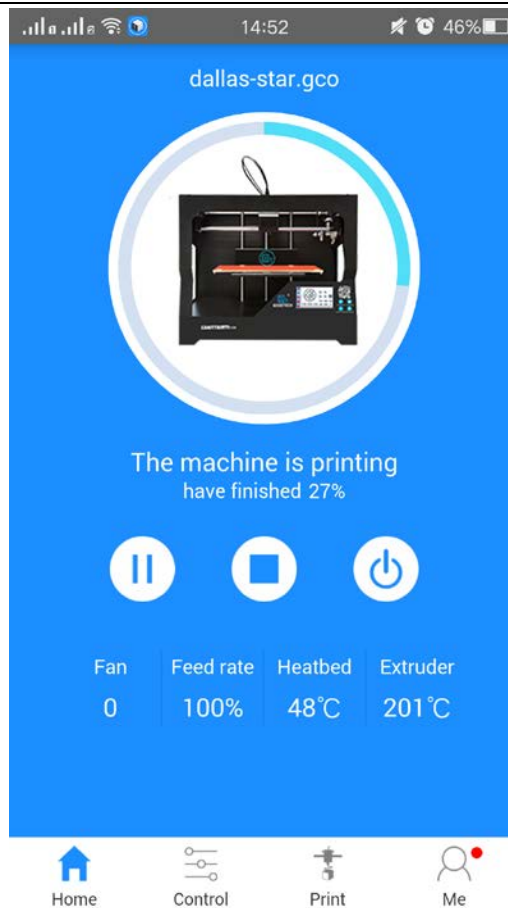

7. Featured Functions of GIANTARM D200

7.1 Break-resuming

The break-resuming capacity, a resurrection system, is added to save real-time printing status and resume the printing job exactly at the same place where it has been stopped. There are two kinds of conditions for pause print: Active and Passive.

Active break-resuming capability allows you to temporarily stop the printer. In this way, you can continue printing after replacing the filament or turn off the power to continue printing in next time. Passive break-resuming capacity is designed to wipe out the repetitive printing job caused by unexpected power outage. Under these two conditions, GiantArm D200 can use the stored power to record the working state and make various parts set to the power-off condition. Once the power recovers, each axis will recover the former state and continue the last printing job, hence effectively saving the filament, greatly increasing the success rate of printing and providing you with a comfortable printing experience.

Note: The break-resuming capacity is only available for printing from SD card or via Wi-Fi. If you print with USB Serial port, after the power is off, the interrupted printing job can't be resumed.

1. Resume printing after pausing print:

Under the conditions of SD card printing and Wi-Fi printing, choose  on the main interface and a prompt will pop up, as shown in the picture below.

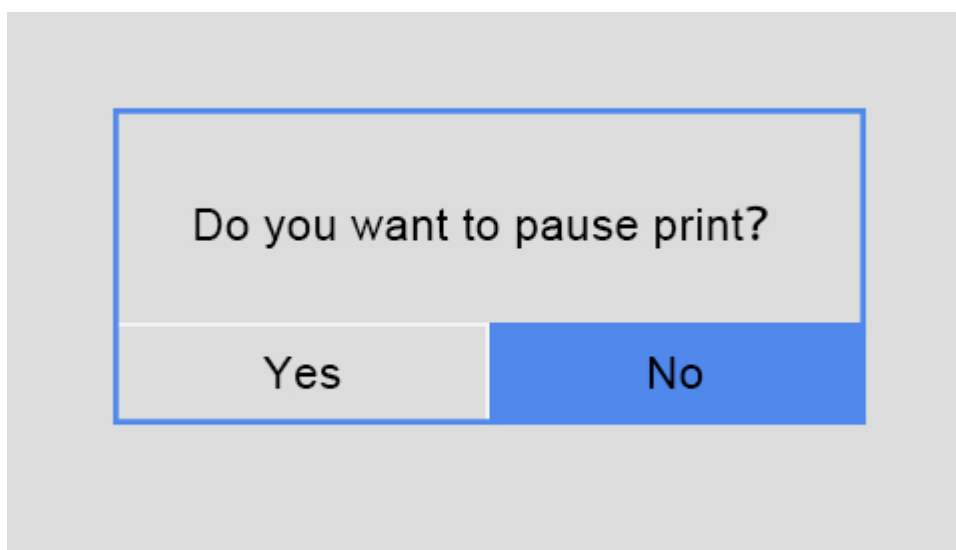

Choose [No] to return to the main interface. The printing continues.

Choose [Yes] and a prompt box will pop up, this prompt enables you to make the following operations:

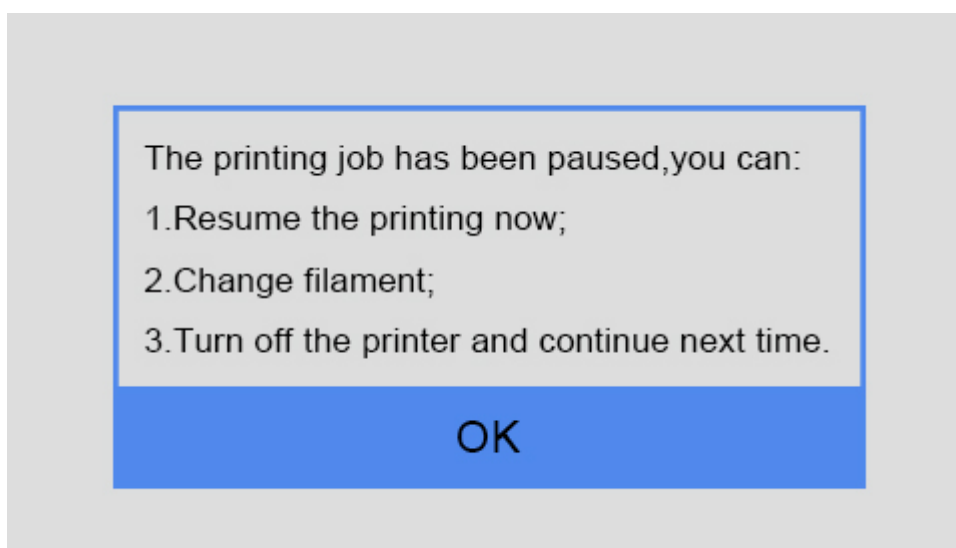

Meanwhile, the printer saves the real-time printing status and homes X/Y/Z axis.

Choose [OK] and return to the main interface.

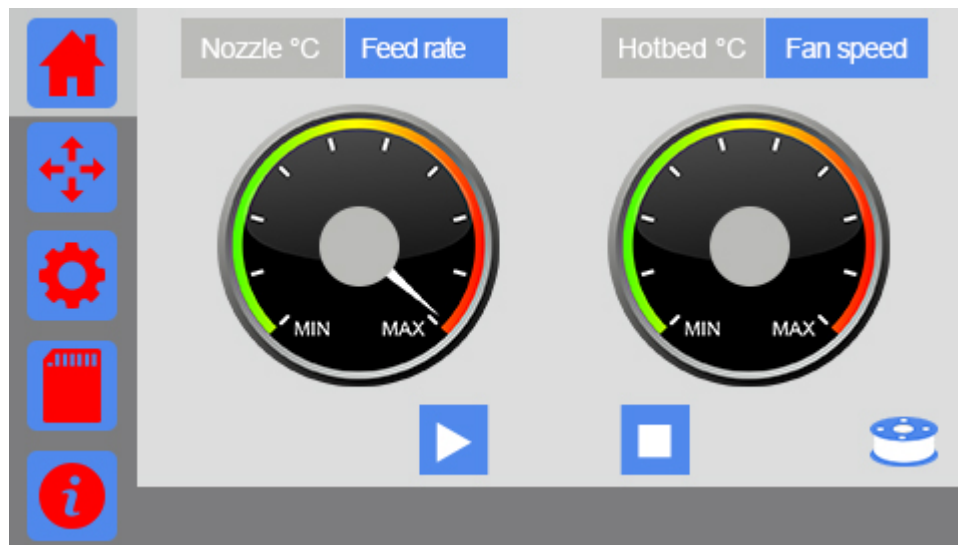

 turns into  on the main interface.

If you want to continue the last printing job, please choose  and pops up the prompt “Recovering the job, wait please...” showing the heating status, as shown in the picture below.

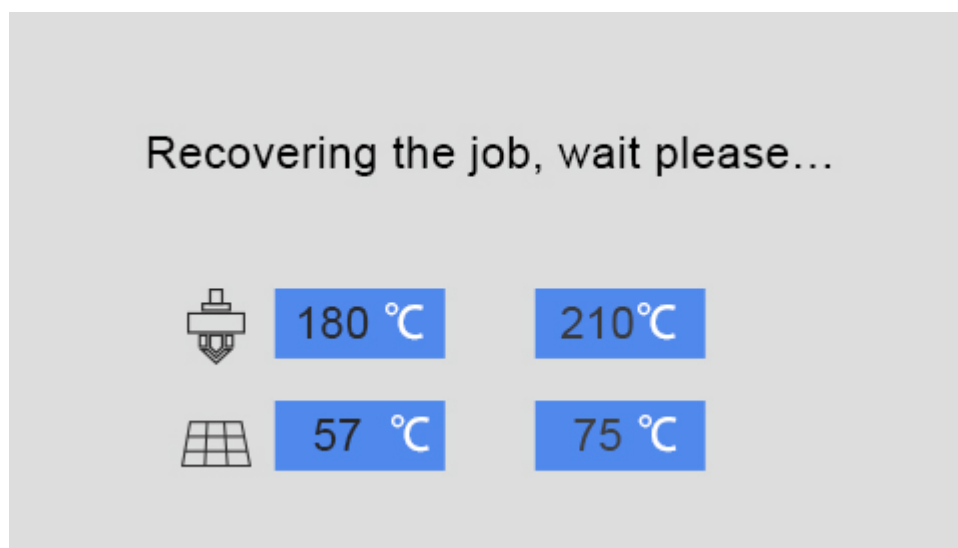

When the heating to the target temperature, the printer will continue printing and the screen will automatically skip to the main interface.

Tips: When your printing job pauses, you can directly turn off the printer and resume it next time.

2. Resume printing after power outage:

If the printing job is interrupted by unexpected power outage when you are printing from SD card or via Wi-Fi, the printer will save the job autonomously.

Next time when you start the printer, you will see a prompt whether to resume the interrupted print job.

An interrupted print job is detected; do you want to resume it?

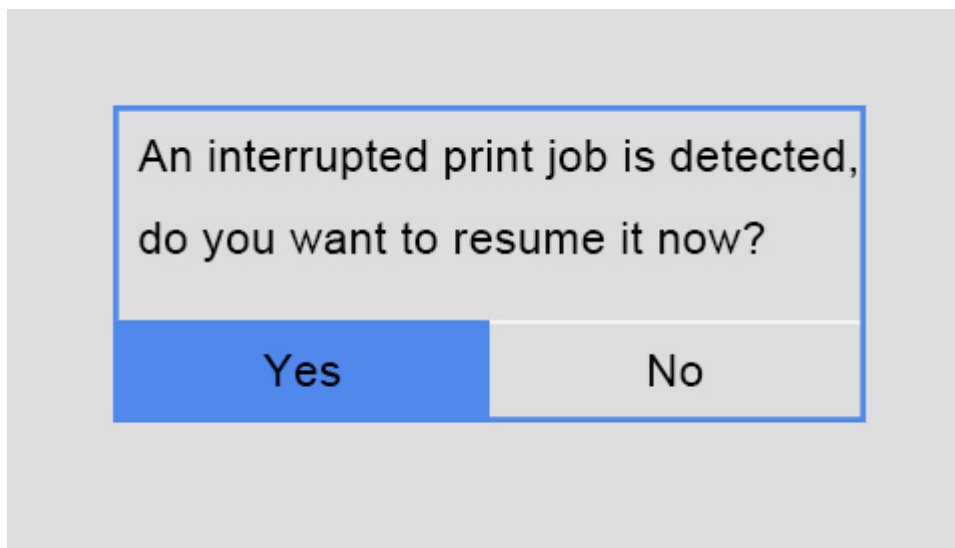

Choose [Yes] to resume your printing job. Meanwhile, the following prompt will appear. Please wait for the extruder and hotbed to reach their respective default temperature, as shown in the picture below.

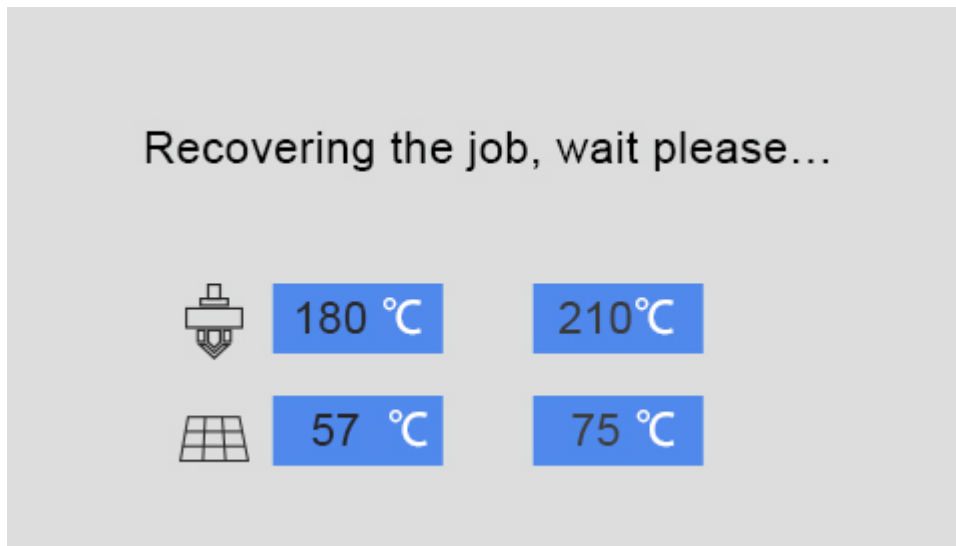

When the heating process finishes, the printer begins to print and the current interface returns to the main one.

Note: If the printer does not detect the unfinished printing file, a prompt comes as follows.

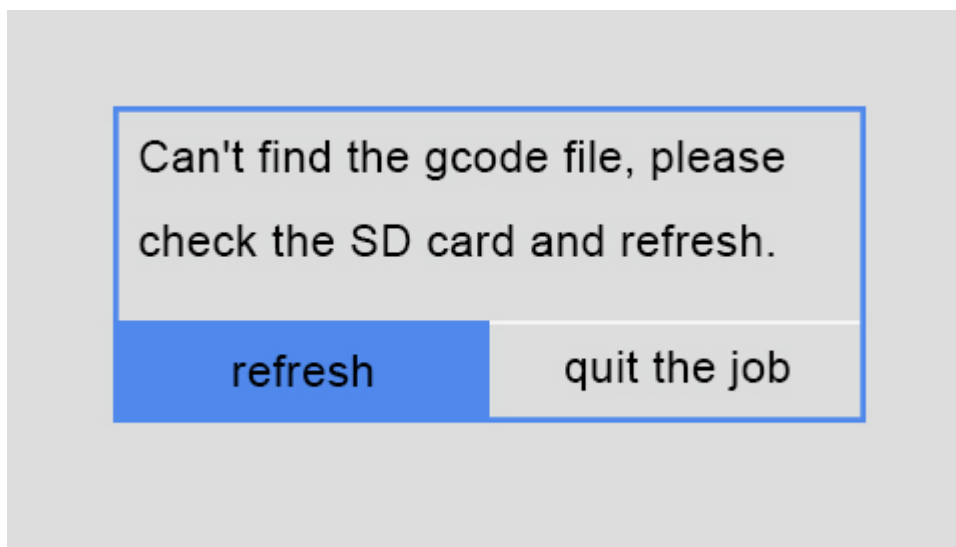

You can check SD card and click [refresh] to detect the file again. If there is no response after refreshing, it is suggested to re-insert SD card and click [refresh].

Choose [quit the job] means that you give up the unfinished object. You can select other 3D model files to print.

3. Resume printing after Restarting:

Under the condition of SD card printing or Wi-Fi printing, no worries, if you carelessly restart the printer.

The control panel will pop up a prompt of resuming printing; you can still continue the print job.

7.2 Filament detector

Filament detector is mainly developed to prevent printing failure caused by filament fracture or outage during the printing.

Powerful filament detector system of GIANTARM can actively suspend the printing and send out an alarm and notification (APP printing). The printer also records the real-time printing status when abnormal signal about filament is detected.

Note:

1. The break-resuming capacity is only suitable for SD card printing or Wi-Fi printing. If you printing with USB Serial port, when the power is off, the interrupted printing will not continue.
2. When you are loading filament, please ensure that the filament pass through the filament detector.
3. Before printing, please confirm whether the filament detector is started. (it is turned on as default.)

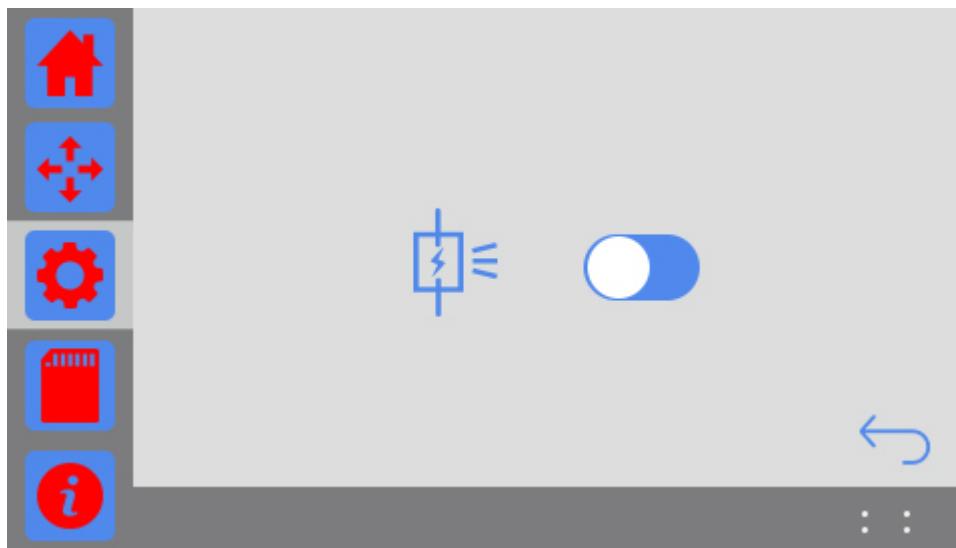

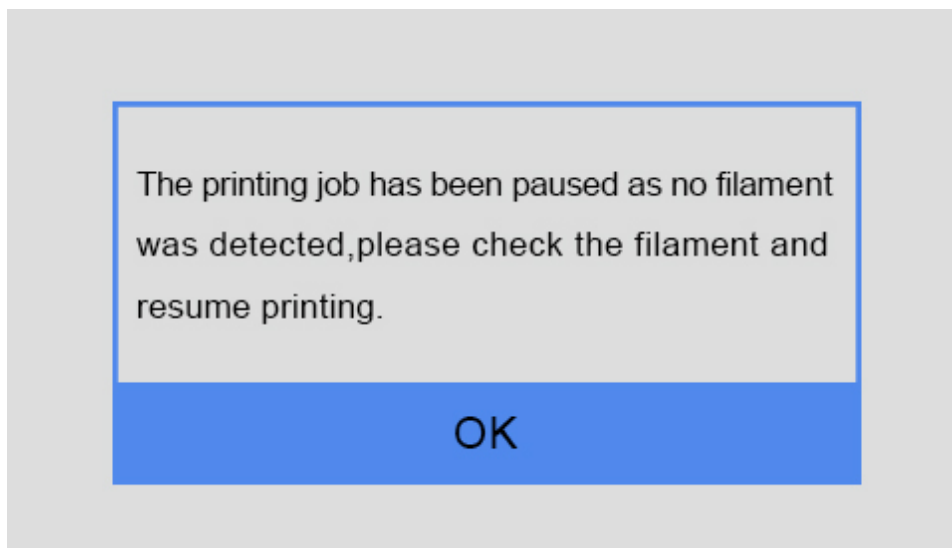
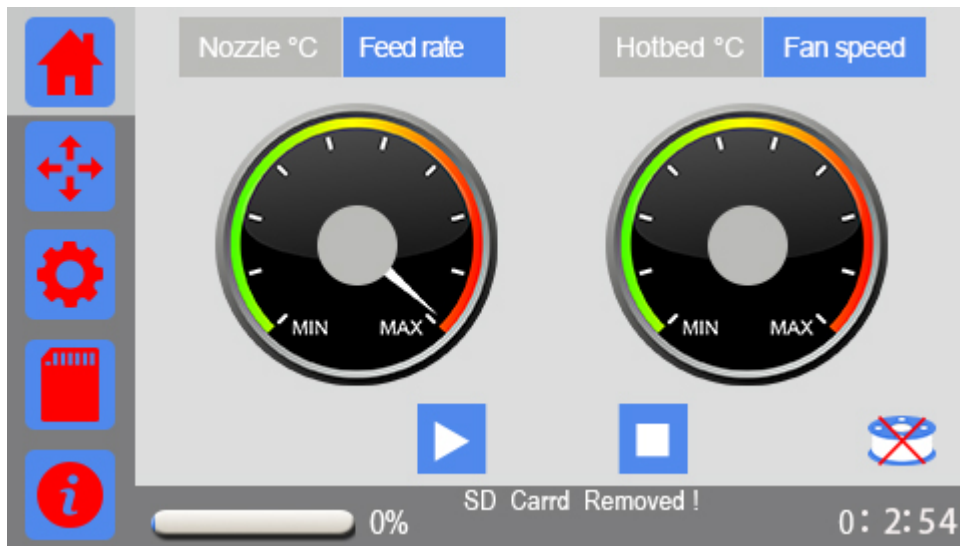

During SD card printing or Wi-Fi printing, if the filament detector cannot detect filament, the printer will immediately stop the current printing and the X/Y/Z axis will be homed.

The printer will also save the current status. Then the filament icon will turn into  at the right bottom corner on home page and pop ups the prompt interface of filament.



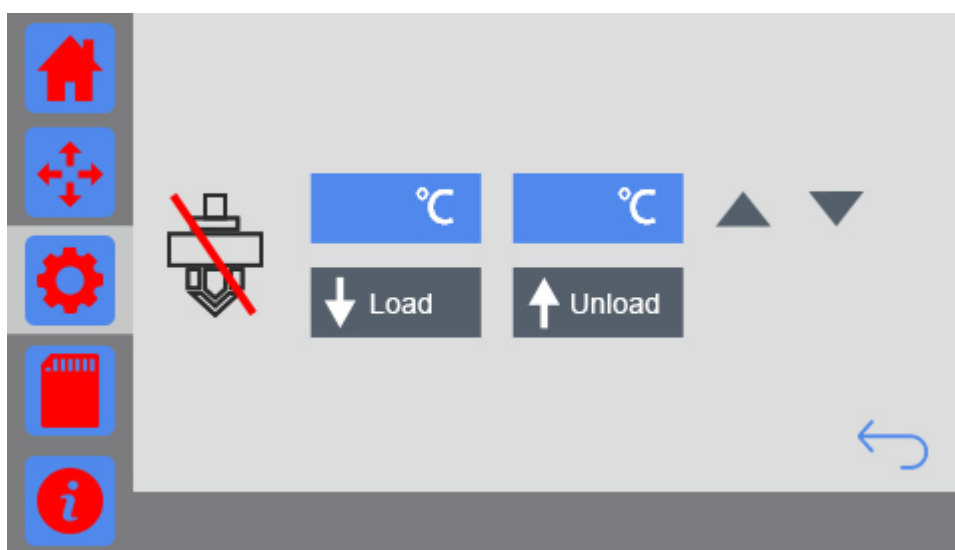

①. Click [OK] to automatically return to the [Filament] interface, as shown in the picture below.

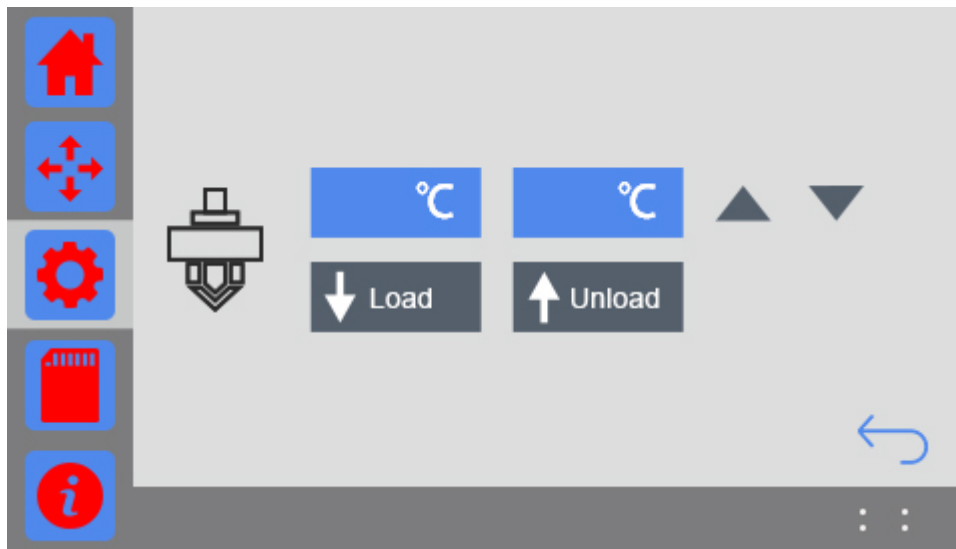

②. Set the target temperature of extruder to about 200°C. Click the icon “” to heat it up. When the temperature reaches the target value, choose [unload] to take the filament out of the extruder, and then load the new filament.

[\(The details please make reference to Change filament of 3.3.3Filament\)](#)



③. After you finish changing the filament, the current interface will skip to the main interface. Click the button “Print”  to continue the job.

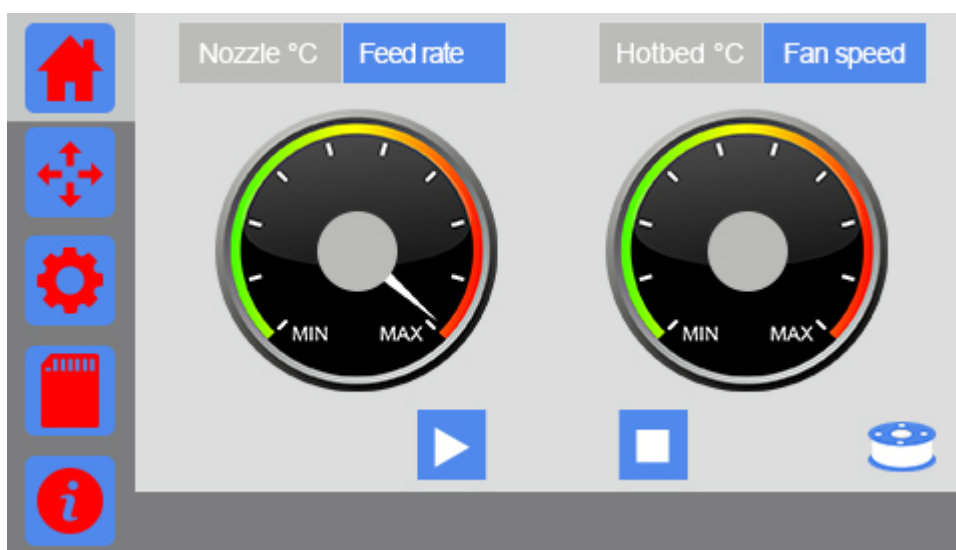

8. FAQ

As your deepening acquaintance with GIANTARM D200 3D printer, you may meet different problems during the printing. The following are simple guidelines to help you easily solve some issues. If you need more helps, please visit https://www.geeetech.com/wiki/index.php/Print_Quality_Troubleshooting_Guide.

8.1 About printing problem

8.1.1 Not extruding at the beginning of print

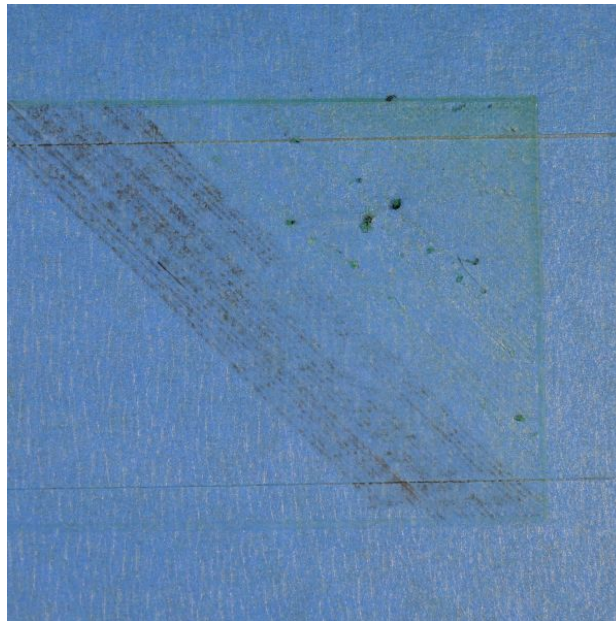

This issue is a very common one for new 3D printer owners, but thankfully, it is also very easy to resolve! If your extruder is not extruding plastic at the beginning of your print, there are four possible causes. We will walk through each one below and explain what settings can be used to solve the problem.

Troubleshooting

1. Extruder was not primed before beginning the print

Most extruders have a bad habit of leaking plastic when they are sitting idle at a high temperature. The hot plastic inside the nozzle tends to ooze out of the tip, which creates a void inside the nozzle where the plastic has drained out. This idle oozing can occur at the beginning of a print when you are first preheating your extruder, and also at the end of the print while the extruder is slowly cooling. If your extruder has lost some plastic due to oozing, the next time you try to extrude, it is likely that it will take a few seconds before plastic starts to come out of the nozzle again. If you are trying to start a print after you nozzle has been

oozing, you may notice the same delayed extrusion. To solve this issue, make sure that you prime your extruder right before beginning a print so that the nozzle is full of plastic and ready to extrude. A common way to do this in EasyPrint is by including something called a skirt. The skirt will draw a circle around your part, and in the process, it will prime the extruder with plastic. If you need extra priming, you can increase the number of skirt outlines on the in EasyPrint.

2. Nozzle starts too close to the bed

If the nozzle is too close to the build table surface, there will not be enough room for plastic to come out of the extruder. The hole in the top of the nozzle is essentially blocked so that no plastic can escape. An easy way to recognize this issue is if the print does not extrude plastic for the first layer or two, but begins to extrude normally around the 3rd or 4th layers as the bed continues to lower along the Z-axis. To solve this problem, you can use the very handy G-Code offsets which can be found on the G-Code tab of EasyPrint's process settings. This allows you to make very fine adjustments to the Z-axis position without needing to change the hardware. For example, if you enter a value of 0.05mm for the Z-axis G-Code offset, this will move the nozzle 0.05mm further away from the print bed. Keep increasing this value by small increments until there is enough room between the nozzle and the build platform for the plastic to escape.

3. The filament has stripped against the drive gear

Most 3D printers use a small gear to push the filament back and forth. The teeth on this gear bite into the filament and allow it to accurately control the position of the filament. However, if you notice lots of plastic shavings or it looks like there is a section missing from your filament, then it's possible that the drive gear has removed too much plastic. Once this happens, the drive gear won't have anything left to grab onto when it tries to move the filament back and forth. Please see the Grinding Filament section for instructions on how to fix this issue.

4. The extruder is clogged

If none of the above suggestions are able to resolve the issue, then it is likely that your extruder is clogged. This can happen if foreign debris is trapped inside the nozzle, when hot plastic sits inside the extruder too long, or if the thermal cooling for the extruder is not sufficient and the filament begins to soften outside of the desired melt zone. Fixing a clogged extruder may require disassembling the extruder, so please contact your printer manufacturer before you proceed. We have had great success using the "E" string on a guitar to unclog extruders by feeding it into the nozzle tip; however, your manufacturer should also be able to provide recommendations.

8.1.2 Print Not Sticking to the Bed

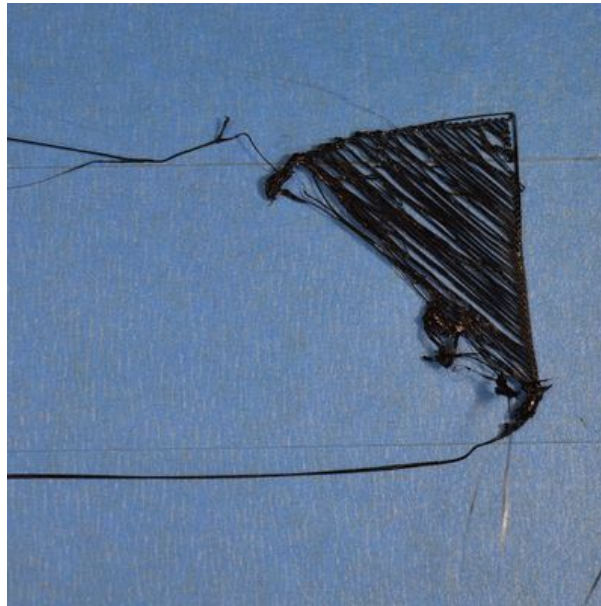

It is very important that the first layer of your print is strongly connected to the printer's build platform so that the remainder of your part can be built on this foundation. If the first layer is not sticking to the build platform, it will create problems later on. There are many different ways to cope with these first layer adhesion problems, so we will examine several typical causes below and explain how to address each one.

Troubleshooting

1. Build platform is not level

Many printers include an adjustable bed with several screws or knobs that control the position of the bed. If your printer has an adjustable bed and you're having trouble getting your first layer to stick to the bed, the first thing you will want to verify is that your printer's bed is flat and level. If the bed is not level, one side of your bed may be too close to the nozzle, while the other side is too far away. Achieving a perfect first layer requires a level print bed. EasyPrint already includes a useful bed leveling wizard that you guide you through the bed leveling process. You can find this wizard by going to Tools > Bed Leveling Wizard, and following the on-screen instructions.

2. First layer is printing too fast

As you extrude the first layer of plastic on top of the build platform, you want to make sure that plastic can properly bond to the surface before starting the next layer. If you print the first layer too fast, the plastic may not have time to bond to the build platform. For this reason, it is typically very useful to print the first layer at a slower speed so that the plastic has time to bond to the bed. EasyPrint provides a setting for this exact

feature. Go to the speed tab; you will see a setting labeled “First Layer Speed”. For example, if you set a first layer speed of 50%, it means that your first layer will print 50% slower than the rest of your part. If you feel that your printer is moving too fast on the first layer, try reducing this setting.

8.1.3 Stringing or Oozing

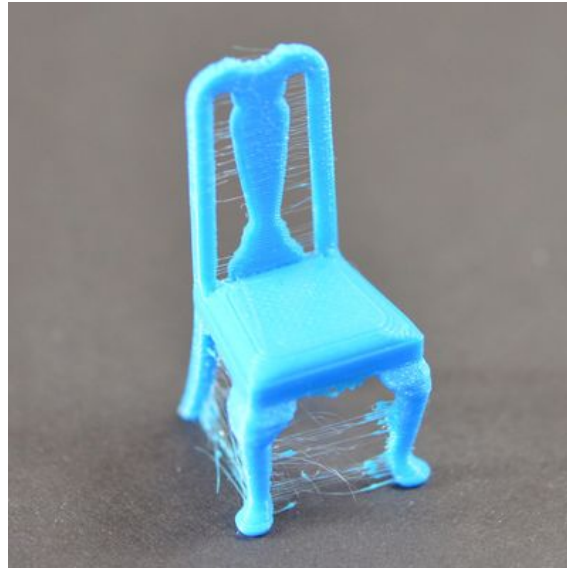

Stringing (otherwise known as oozing, whiskers, or “hairy” prints) occurs when small strings of plastic are left behind on a 3D printed model. This is typically due to plastic oozing out of the nozzle while the extruder is moving to a new location. Thankfully, there are several settings within EasyPrint 3D that can help with this issue. The most common setting that is used to combat excessive stringing is something that is known as retraction.

If retraction is enabled, when the extruder is done printing one section of your model, the filament will be pulled backwards into the nozzle to act as a countermeasure against oozing. When it is time to begin printing again, the filament will be pushed back into the nozzle so that plastic once again begins extruding from the tip. To ensure retraction is enabled, click “Settings”, choose [custom] mode and click on Retraction tab. In the sections below, we will discuss the important retraction settings as well as several other settings that can be used to combat stringing, such as the extruder temperature settings.

Troubleshooting

1. Retraction distance

The most important retraction setting is the retraction distance. This determines how much plastic is pulled out of the nozzle. In general, the more plastic that is retracted from the nozzle, the less likely the nozzle is to ooze while moving. Most direct-drive extruders only require a retraction distance of 0.5-2.0mm, while some Bowden extruders may require a retraction distance as high as 15mm due to the longer distance between the extruder drive gear and the heated nozzle. If you encounter stringing with your prints, try increasing the retraction distance by 1mm and test again to see if the performance improves.

2. Retraction speed

The next retraction setting that you should check is the retraction speed. This determines how fast the filament is retracted from the nozzle. If you retract too slowly, the plastic will slowly ooze down through the nozzle and may start leaking before the extruder is done moving to its new destination. If you retract too quickly, the filament may separate from the hot plastic inside the nozzle, or the quick movement of the drive gear may even grind away pieces of your filament. There is usually a sweet spot somewhere between 1200-6000 mm/min (20-100 mm/s) where retraction performs best. Thankfully, EasyPrint has already provided many pre-configured profiles that can give you a starting point for what retraction speed works best, but the ideal value can vary depending on the material that you are using, so you may want to experiment to see if different speeds decrease the amount of stringing that you see.

3. Temperature is too high

Once you have checked your retraction settings, the next most common cause for excessive stringing is the extruder temperature. If the temperature is too high, the plastic inside the nozzle will become extremely viscous and will leak out of the nozzle much more easily. However, if the temperature is too low, the plastic will still be somewhat solid and will have difficulty extruding from the nozzle. If you feel you have the correct retraction settings, but you are still encountering these issues, try decreasing your extruder temperature by 5-10 degrees. This can have a significant impact on the final print quality. You can adjust these settings by clicking “Edit Process Settings” and selecting the Temperature tab. Select your extruder from the list on the left, and then double-click on the temperature set point you wish to edit.

For more tips on improving printing quality, please take a glance at:

https://www.geeetech.com/wiki/index.php/Print_Quality_Troubleshooting_Guide .

8.2 How to upload the firmware?

EasyPrint 3D provides all the users with online service of upgrading firmware to guarantee perfect printing performance.

The specific method is as follows:

1. Connect your GEEETECH 3D printer to the computer with the USB cable.
2. Turn the printer on.
3. In Easy Print 3D, choose the COM port and the printer type.
4. Click 'help'>'Update firmware'.

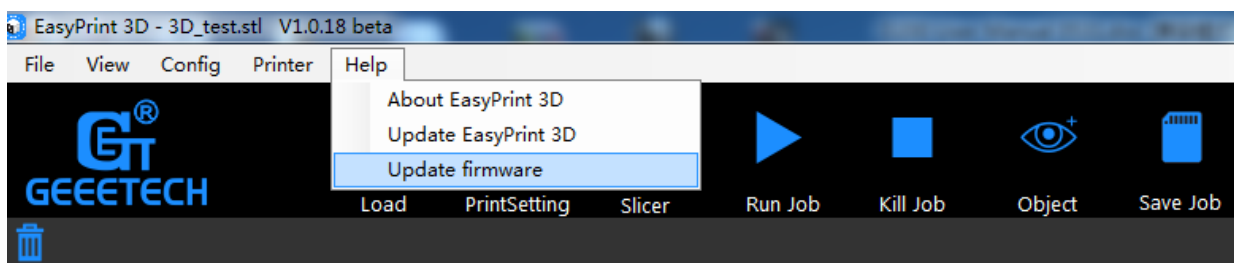
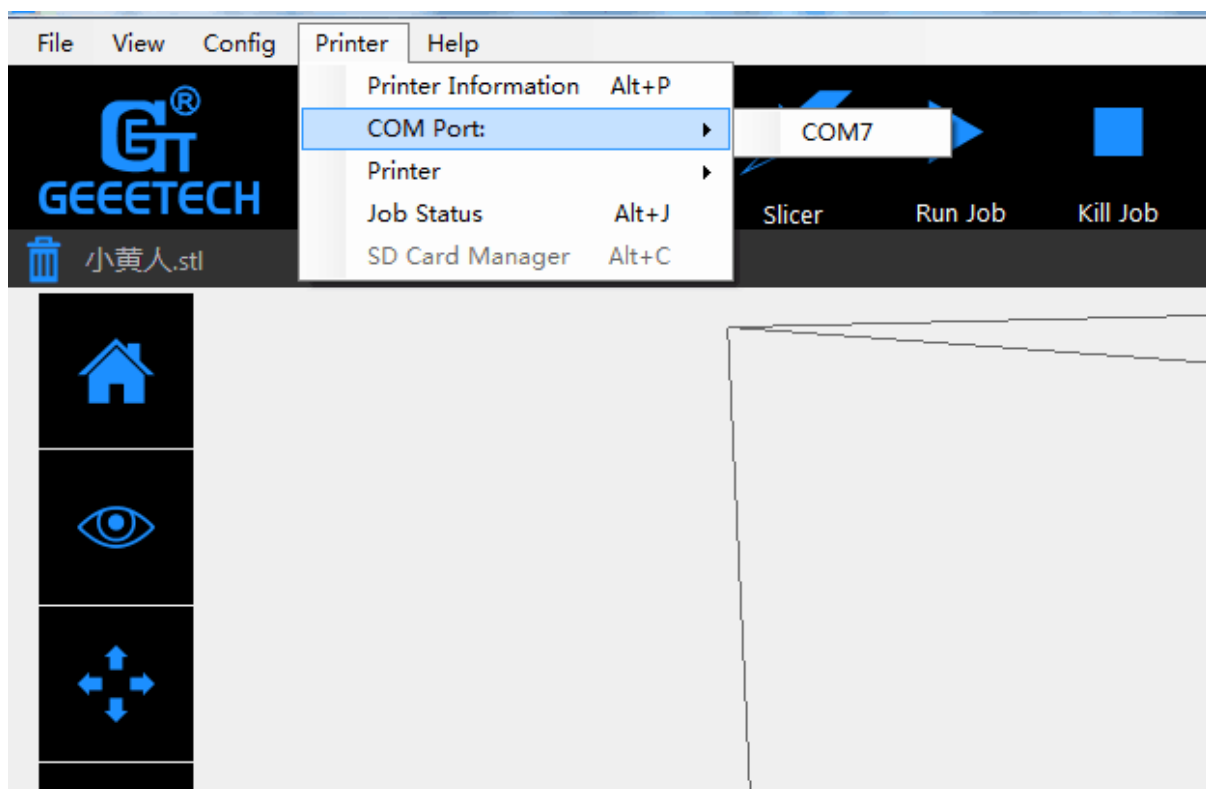

After clicking the [upgrade firmware] tab, a window will pop up with the information of printer type and port, the current firmware version installed, the available version and the update summary of the latest firmware.

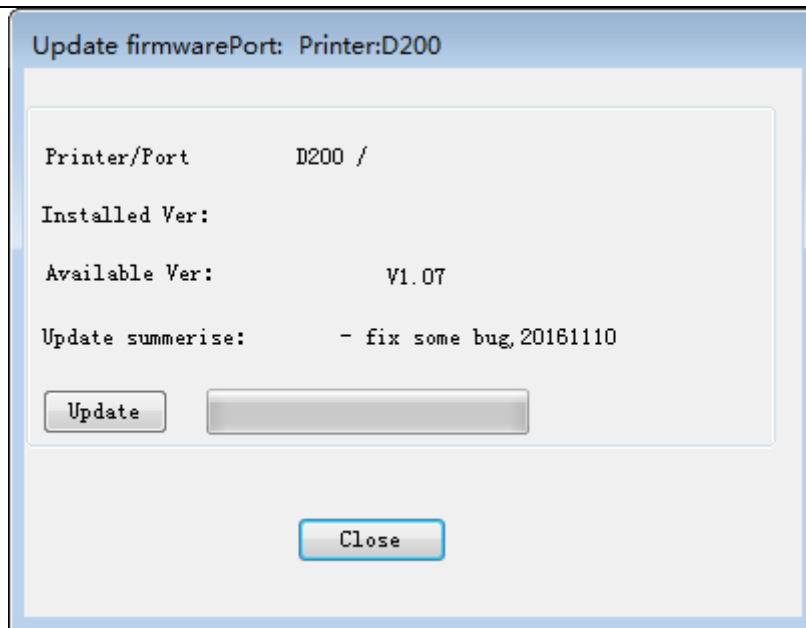

Click **updates** and confirms updating, the progress bar will turn green, and the firmware will be updated automatically. This process may take some time.

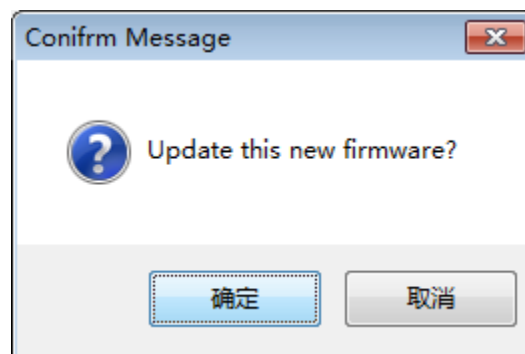

When the upload is complete the message 'update successes will be displayed.

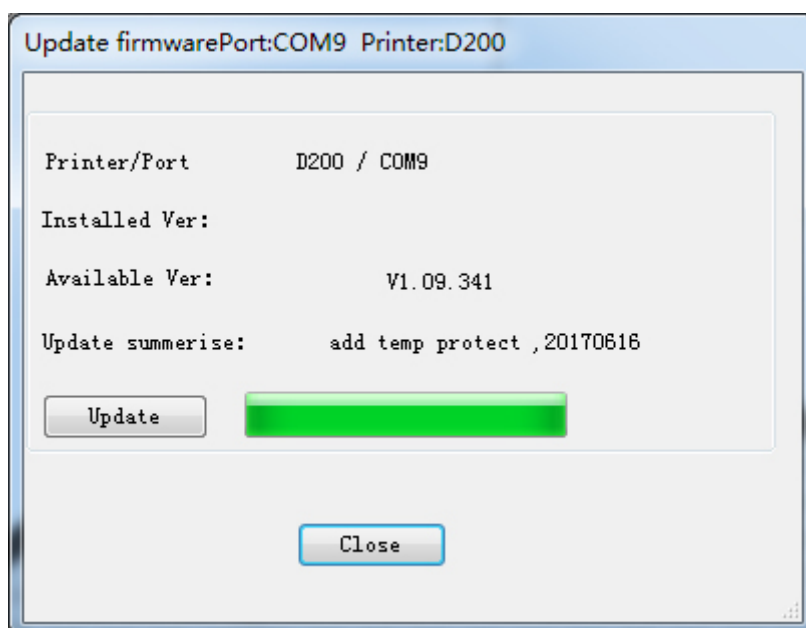

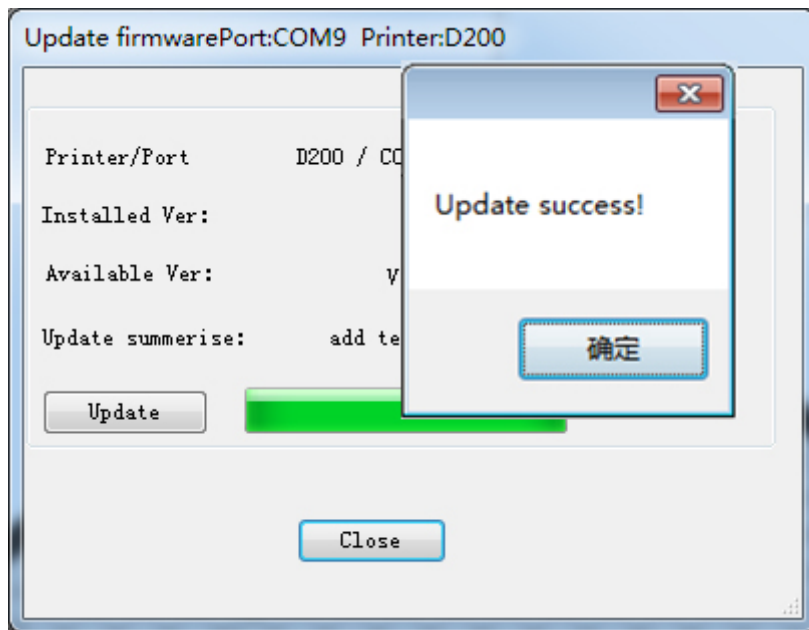

Click 'ok' and 'Close' on the windows to complete the firmware upgrade.

8.3 How to change the extruder

The extruder of GiantArm D200 is characterized by its modular design. Specifically speaking, the coldend and hotend are combined together by a sliding joint, making it easy to change the extruder.

- 1) Find the switch on the left of the nozzle and slide it to the left slowly to take out the nozzle;

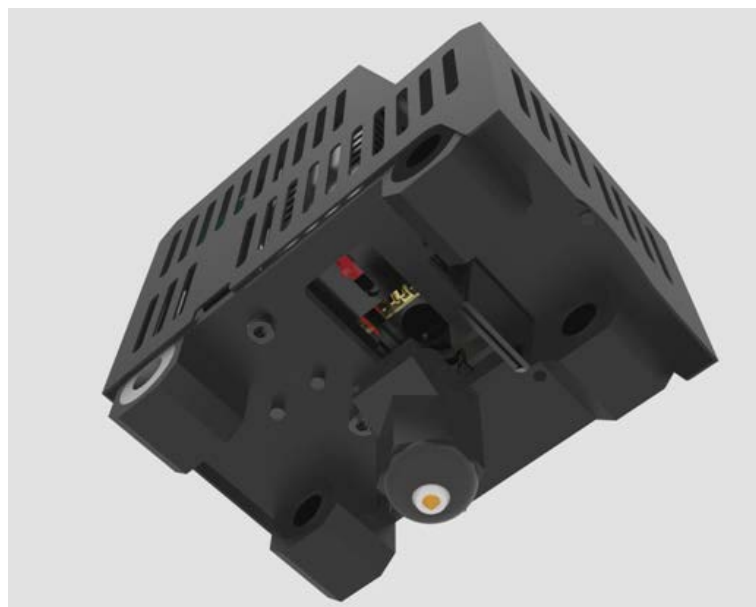

Here is the picture after you move the nozzle.



- 2) Assemble the new nozzle and slide the switch to the right to lock the nozzle. This is the operation flow of change a new nozzle.



**NOTE:**

- 1) It is essential to wait for the temperature of the extruder to decrease to the indoor temperature before you change the nozzle. It is when the temperature of the nozzle totally returns to the indoor temperature that you could conduct the above operation. Be careful to not be scalded.
- 2) It is necessary to clear the debris of filament in the extruder before you change the new nozzle. This petty step makes it easy to change the nozzle.

8.4 Fail to complete the Wi-Fi configuration

Tips:

- 1) At ④, if the Wi-Fi built in the printer could be detected, please exit from Set mode, turn the button Wi-Fi off and turn it on again. Enter the Set mode to continue the configuration.
- 2) At ⑥, enter the password and click “[OK]” . If a prompt “Not connect with Printer Wi-Fi “pops up, please manually connect with Printer Wi-Fi or again make the configuration.
click “[OK]” and manually make the mobile Wi-Fi switch to Printer Wi-Fi (GT-printer). Then come back to APP and click “[Next]” to redetect or return to the page of Wi-Fi configuration to make the new one.
- 3) At ⑥, if a prompt of configuration fails to appear, please start again to make the configuration.

4) If you have any questions, please contact with our technical support.

9. Technical Specifications

Printing specifications:

Print technology: FDM

Build volume: 300 x180x180mm

Printing precision: 0.05mm

Positioning precision: X/Y: 0.011mm Z: 0.0025mm

Print Speed: 80-110mm/s

Filament diameter: 1.75mm

Nozzle diameter: 0.4mm

Filament type: ABS/PLA/flexible PLA/wood-polymer/ PVA, HIPS, PETG etc.

Software:

Control software: EasyPrint 3D, Repetier-Host, Cura

Slicing software: EasyPrint 3D , Slic3r, Cura

3D model file format: .gcode/ .stl

Support Operation system: Windows, Mac

Temperature:

Max heated bed temperature: 110 °C Max extruder temperature: 230°C

Electrical:

Power input: 110V-240V Power output: DC24V/360W

Connectivity: USB, SD card, Wi-Fi

Mechanical:

Chasis: Metal sheet

Build Platform: Metal sheet +Glass +heatbed

Stepper Motors: 1.8°step angle with 1/16 micro-stepping

XYZ Rods: Carbon steel line guide + lead screw (Z axis)

Physical Dimensions & Weight:

Machine Dimension: 470mmx350mmx395mm

Shipping box Dimension: 590mmx490mmx510 mm

Net weight: 16.5kg

Gross weight: 21.6kg

Shipping weight: 29.48 kg

10 Contact us

Technical support	<p>1. There are lots of documents and troubleshooting for GiantArm D200on our website. They are good resources if you would like to quickly solve problems by yourself.</p> <p>2.If you still cannot solve problems yourself even with the help of above files, you can send e-mail to technical@giantarm.com,we will reply to you within 24 hours.</p>
--------------------------	---

Sales	For more products of Geetech, please visit www.geetech.com or send e-mail to sales@giantarm.com
Feedback	In order to improve our products to provide better user experience, please send your comments and suggestions to feedabck@giantarm.com . We will appreciate to hear your valuable suggestions.